

Review of California's Water Recycling Criteria for Agricultural Irrigation

*Recommendations
of an NWRI
Independent
Advisory Panel*

September 2012



Prepared By:
Robert C. Cooper (Chair),
Adam W. Olivieri (Vice Chair),
Michael D. Cahn, John Colford,
James Crook, Jean-François Debroux,
Robert Mandrell, Trevor Suslow,
and George Tchobanoglous

Final Report

Review of California's Water Recycling Criteria for Agricultural Irrigation

Recommendations of an NWRI Independent Advisory Panel

Panel Members:

Robert C. Cooper (Chair)
Adam W. Olivieri (Vice Chair)
Michael D. Cahn
John Colford
James Crook
Jean-François Debroux
Robert Mandrell
Trevor Suslow
George Tchobanoglous

Submitted to:

California Department of Public Health
1616 Capitol Avenue
Sacramento, CA 95899

Submitted by:

National Water Research Institute
18700 Ward Street
P.O. Box 8096
Fountain Valley, CA 92728-8096

September 2012

ABOUT NWRI

A 501c3 nonprofit organization, the National Water Research Institute (NWRI) was founded in 1991 by a group of California water agencies in partnership with the Joan Irvine Smith and Athalie R. Clarke Foundation to promote the protection, maintenance, and restoration of water supplies and to protect public health and improve the environment. NWRI's member agencies include Inland Empire Utilities Agency, Irvine Ranch Water District, Los Angeles Department of Water and Power, Orange County Sanitation District, Orange County Water District, and West Basin Municipal Water District.

For more information, please contact:

National Water Research Institute
18700 Ward Street
P.O. Box 8096
Fountain Valley, California 92728-8096 USA
Phone: (714) 378-3278
Fax: (714) 378-3375
www.nwri-usa.org

Jeffrey J. Mosher, Executive Director
Gina Melin Vartanian, Editor

Publication Number NWRI-2012-03

ACKNOWLEDGMENTS

The Review of Water Recycling Criteria for Agricultural Irrigation Independent Advisory Panel (Panel) wishes to thank the California Department of Public Health (CDPH) for their financial support for this effort. Funding was provided by CDPH through Agreement 09-11736. The Panel thanks Mr. Mark Bartson and Ms. Lynda Dyane of CDPH as the CDPH project representatives on this effort.

The Panel Members also wish to thank the CDPH staff for the opportunity to serve on this Panel. The Panel is grateful for the many questions and suggestions received from CDPH staff during several meetings. In particular, the Panel thanks Mr. Robert Hultquist, Dr. David Spath, and Mr. Mark Bartson of CDPH for supporting the Panel. The working environment and support provided by CDPH were excellent, which the Panel very much appreciated.

The Panel Members also wish to thank the National Water Research Institute (NWRI) for administering and supporting the Panel's efforts. The Panel thanks Mr. Jeff Mosher for coordinating the Panel's activities and meetings, as well as supporting the Panel's deliberations. The Panel thanks Ms. Gina Vartanian of NWRI for writing and editing support.

The Panel also wishes to acknowledge the support of Dr. Edmund Seto (University of California, Berkeley, School of Public Health) and Mr. Ray Goebel (EOA, Inc.) for assisting with report preparation and conducting the quantitative microbial risk assessment (QMRA).

Members of the Panel include:

- Robert C. Cooper, Ph. D. (Panel Chair), University of California (Berkeley, CA)
- Adam W. Olivieri, Dr. PH, P.E. (Vice Chair), EOA, Inc. (Oakland, CA)
- Michael D. Cahn, Ph.D., University of California, Cooperative Extension (Salinas, CA)
- John Colford, Jr., M.D., Ph.D., MPH, University of California (Berkeley, CA)
- James Crook, Ph.D., P.E., Water Reuse Consultant (Boston, MA)
- Jean-François Debroux, Ph.D., Kennedy/Jenks Consultants (San Francisco, CA)
- Robert Mandrell, Ph.D., U.S. Department of Agriculture (Albany, CA)
- Trevor Suslow, Ph.D., University of California, Davis (Davis, CA)
- George Tchobanoglous, Ph.D., P.E., NAE, University of California, Davis (Davis, CA)

DISCLAIMER

This report was prepared by an NWRI Independent Advisory Panel, which is administered by the National Water Research Institute (NWRI). Any opinions, findings, conclusions, or recommendations expressed in this report were prepared by the Panel. This report was published for informational purposes.

CONTENTS

ACRONYMS AND ABBREVIATIONS	vii
EXECUTIVE SUMMARY	ix
1.0 INTRODUCTION.....	1-1
1.1 The NWRI Independent Advisory Panel	1-2
1.2 Charge to the Panel	1-3
1.3 Organization of the Report.....	1-3
2.0 CALIFORNIA WATER REUSE AND PUBLIC HEALTH REGULATIONS	2-1
2.1 California Water Recycling.....	2-1
2.1.1 Current Levels of Water Recycling and Future Resource Demands.....	2-1
2.1.2 Agricultural Irrigation Reuse.....	2-2
2.2 SWRCB and CDPH Regulations/Guidance and Relationship.....	2-3
2.3 Overview of Microbial Pathogens and Public Health Concerns.....	2-5
2.3.1 Pathogenic Microorganisms	2-5
2.3.2 Infectious Disease Transmission	2-7
2.4 Summary of Epidemiological Evidence of Infectious Disease Incidence Associated with Water Reuse	2-11
3.0 PUBLIC HEALTH RELEVANCE OF MICROBIAL PATHOGENS IN RECYCLED WATER TO HUMAN HEALTH	3-1
3.1 Pathogens of Public Health Concern.....	3-1
3.2 Pathogens of Public Health Concern for Agricultural Reuse on Food Crops	3-2
3.3 Quantitative Microbial Risk Assessment	3-3
3.4 Quantitative Microbial Risk Assessment Approach	3-5
3.5 Quantitative Microbial Risk Assessment Results and Conclusions.....	3-12
3.6 Acceptable or Tolerable Risk.....	3-20
4.0 REVIEW OF KEY CDPH WATER RECYCLING CRITERIA PERFORMANCE STANDARDS	4-1
4.1 Q3: What Is the Basis for the Current 5-Log Virus Reduction Criteria? Is the Criterion Still Relevant? And Q4: What Is the Basis for the 450-mg/min/L CT Chlorine Disinfection Criteria?.....	4-1
4.2 Q5: How Should Multi-Barrier Treatment and Effectiveness Be Defined? How Should It Be Evaluated?.....	4-7
4.3 Q6: Is the Current <2 NTU (Average Daily) Turbidity Criteria Still a Valid Filtration Performance Standard?	4-7

4.4 Q7: Should Performance Standards Be Used to Define/Characterize Secondary Treatment?	4-10
4.5 Q8: Are Total Coliforms Still an Appropriate Indicator of Overall Disinfection Performance?	4-10
4.6 Q9: Do Crops Take Up Pathogenic Viruses? If Yes, Is this Route of Exposure a Public Health Concern for Agriculture Irrigation with Recycled Water?	4-19
5.0 FUTURE INVESTIGATIONS	5-1
5.1 Augment Water Recycling Criteria Turbidity Requirement with Particle Size and Distribution Performance Measure	5-1
5.2 Review of CT Requirement.....	5-3

APPENDICES

Appendix 1-1: NWRI Independent Advisory Panel Members	
Appendix 1-2: CDPH Agricultural Irrigation with Recycled Water - The Concerns	
Appendix 1-3: Panel Meeting Notes and Presentations	
Appendix 2-1: Summary of California Water Recycling Regulations and Statutes	
Appendix 3-1: Summary of Bar Graphs for Pathogen Literature Review	
Appendix 3-2: Example per Event Risk Estimates for Scenario I	
Appendix 3-3: Summary Statistics for Risk Distributions for Tables 3-7, 3-8, and 3-9	
Appendix 4-1: Data and Inactivation Curves from “Microbial Challenges Studies and Estimations of Process Train Performance” (1997)	

TABLES

Table E.1 Scenarios for Agriculture Reuse, Treatment, and Conseravtive Exposure Assumptions.....	x
Table 1.1 Agriculture Irrigation Reuse Option and Required Treatment	1-1
Table 1.2 Panel Members	1-2
Table 2.1 Summary of California Department of Public Health Water Reuse Treatment Requirements.	2-4
Table 2.2 Water-Related Infectious Agents.....	2-6
Table 2.3 Summary of Literature Review for Enteric Virus Mean Concentrations in Wastewater Treatment Process Effluent	2-8
Table 2.4 Summary of Literature Review for <i>Cryptosporidium</i> Mean Concentrations in Wastewater Treatment Process Effluent	2-9

Table 2.5 Summary of Literature Review for <i>Giardia</i> Mean Concentrations in Wastewater Treatment Process Effluent.....	2-10
Table 2.6 Dose of Pathogens Required for 25 to 75 Percent Illness Response in Humans.....	2-10
Table 3.1 Comparison of Static and Dynamic Risk Assessment Models.....	3-5
Table 3.2 Summary of Raw Wastewater Pathogen Concentration Distributions Used for Modeling.....	3-7
Table 3.3 Table From Literature Review for <i>E. coli</i> O157:H7.....	3-8
Table 3.4 Summary of Pathogen Reductions through Wastewater Treatment Used in the Simulations	3-8
Table 3.5 Agriculture Reuse, Treatment, and Exposure Assumptions.....	3-10
Table 3.6 Summary of Pathogen Dose Response Relations	3-11
Table 3.7 Scenario I. Tertiary Treatment Applied Directly to Crops. Summary of Median Annualized Risks of Infection Assuming All Exposures in the Year Are to Crops Irrigated with Reclaimed Water.....	3-12
Table 3.8 Scenario II. Secondary Undisinfected Effluent, Not Directly Applied to Edible Portion of Crop. Summary of Median Annualized Risks of Infection Assuming All Exposures in the Year Are to Crops Irrigated with Reclaimed Water.....	3-13
Table 3.9 Scenario III. Secondary Disinfected, Not Directly Applied to Edible Portion of Crop. Summary of Median Annualized Risks of Infection Assuming All Exposures in the Year Are to Crops Irrigated with Reclaimed Water.....	3-13
Table 3.10 Scenario I. Tertiary Treatment Applied Directly to Crops. Summary of Annualized Risks of Infection Assuming 8 Percent of Exposures in the Year Are to Crops Irrigated with Reclaimed Water	3-14
Table 3.11 Sensitivity Analysis for Enterovirus Annualized Risk Estimates of Environmental Decay Rates	3-16
Table 3.12 Scenario II. Secondary Undisinfected, Not Directly Applied to Edible Portion of Crop. Summary of Annualized Risks of Infection Assuming All Exposures in the Year Are to Crops Irrigated with Reclaimed Water	3-18
Table 3.13 Scenario III. Secondary Disinfected, Not Directly Applied to Edible Portion of Crop. Summary of Annualized Risks of Infection Assuming All Exposures in the Year Are to Crops Irrigated with Reclaimed Water	3-18
Table 4.5 Range of Microbe Concentration in Treatment Effluent.....	4-14
Table 4.6 Overall Geometric Average Concentration of Microorganisms from the Six Treatment Plants.....	4-15
Table 4.7 Excerpted from WERF Data: Final Effluent Samples From Which Enteric Viruses and Viable <i>Cryptosporidium</i> Oocysts Were Isolated.....	4-16
Table 4.8 Comparison of UV Dose Required for a 5-Log Reduction	4-17
Table 4.9 Summary of Data on Pathogen Infectious Doses (IDs) for Humans.....	4-20

Table 5.1 CT Values (min•mg/L) for 4-Log Inactivation of Viruses by Free Chlorine 5-6

FIGURES

Figure 2.1 Types of wastewater reuse in California as a percentage of annual use (2009)..... 2-2

Figure 3.1 Static risk assessment conceptual model..... 3-4

Figure 3.2 Flow diagram for conducting the microbial risk assessments..... 3-6

Figure 3.3 Distribution of ingestion volumes for the crop irrigation route of exposure for Scenario I..... 3-10

Figure 3.4 Distribution of annualized risk for different exposure assumptions 3-16

Figure 3.5. Sensitivity analysis of treatment efficacy..... 3-17

Figure 4.1 1978 wastewater reclamation treatment train..... 4-2

Figure 4.2 Abbreviated treatment train. Criteria treatment train. 4-2

Figure 4.3. Polio virus removal for chlorine residual ~ 5 mg/L. 4-3

Figure 4.4. Polio virus removal for chlorine residual ~ 10 mg/L. 4-3

Figure 5.1 Definition sketch for the determination of turbidity and light scattering patterns for various size particles 5-2

Figure 5.2 Comparison of the performance of two filters based on turbidity..... 5-3

Figure 5.3 Generalized process flow diagrams for typical treatment processes, all of which include chlorine disinfection for pathogen control: (a) trickling filter for TSS and BOD removal; (b) activated sludge for TSS and BOD removal and nitrification; (c) suspended growth biological treatment for TSS, BOD, and nitrogen removal; (d) suspended growth biological treatment for TSS, BOD, nitrogen, and phosphorus removal; and (e) membrane bioreactor for TSS and BOD removal and nitrification..... 5-5

ACRONYMS

BOD	Biochemical oxygen demand
CCL	Contaminant candidate list
CCR	California Code of Regulations
CDC	Centers for Disease Control
CDPH	California Department of Public Health
CL	Confidence level
CT	Concentration \times time
CWC	California Water Code
EPA	U.S. Environmental Protection Agency
FIB	Fecal indicator bacteria
ID	Infectious dose
LT2	Long-Term 2 Enhanced Surface Water Treatment Rule
MBR	Membrane bioreactor
MLE	Maximum likelihood estimation
MPN	Most probable number
MRA	Microbial risk assessment
QMRA	Quantitative microbial risk assessment
qPCR	Quantitative polymerase chain reaction
NWRI	National Water Research Institute
RWQCB	Regional Water Quality Control Board
SWRCB	State Water Resources Control Board
SWTR	Surface Water Treatment Rule
TSS	Total suspended solids
WERF	Water Environment Research Foundation
WHO	World Health Organization
WRRF	WaterReuse Research Foundation

ABBREVIATIONS FOR UNITS OF MEASURE

FFU	Focus forming units
g/kg-day	Grams per kilogram per day
kg	Kilogram
L	Liter
mg/L	Milligram per liter
mg-min/L	Milligram-minutes per liter
min.	Minute
mJ/cm ²	Millijoule per square centimeter
mL	Milliliter
mL/day	Milliliter per day
nm	Nanometer
NTU	Nephelometric turbidity unit
pfu	Plaque forming units
pppy	People per year
μ m	Micrometer

EXECUTIVE SUMMARY

California currently recycles treated wastewater at a volume of approximately 650,000 acre-feet of water per year, but has identified the potential to recycle an additional 1.5 million acre-feet in the future. To encourage the expanded use of recycled water in a state that is experiencing water shortages, the California State Water Resources Control Board (SWRCB) adopted a Recycled Water Policy in February 2009 intended to provide permitting clarity and direction for water reuse projects (California State Water Resources Control Board, 2009). A key challenge in promoting the expansion of water recycling for agricultural purposes, especially for the use of recycled water for food crop production, was addressing the perceived concern about whether recycled water produced in conformance with California's Water Recycling Criteria is protective of public health.

Recognizing that consideration of the exposure to microbial pathogens present in wastewater and their potential effects on human health is a significant concern, and that the regulatory requirements for recycling treated wastewater need to be based on best available science, the California Department of Public Health (CDPH) and SWRCB included a provision in the Recycled Water Policy to establish an expert Panel. The Panel's primary charge is to *consider whether recycled water produced in conformance with California's Water Recycling Criteria are sufficiently protective of public health for agricultural food crop irrigation.*

Administered by the National Water Research Institute (NWRI), the NWRI Independent Advisory Panel for the Review of California's Water Recycling Criteria for Agricultural Irrigation includes nine nationally recognized experts in the fields of public health microbiology and virology, quantitative microbial risk assessment, public health infectious diseases and epidemiology, water reuse, food safety and hazard analysis, agricultural practices, irrigation management, emerging contaminants of concern (i.e., waterborne infectious agents), and water and wastewater treatment effectiveness. The Panel has over 150 years of combined experience investigating water reuse and potential public health issues. While the Panel was formed in 2008, it did not begin work until the spring of 2010. Over the past 2 years, the Panel held four meetings, a number of subcommittee meetings, and numerous conference calls. The Panel meetings included the opportunity for stakeholder input in clarifying the Panel's charge, exchange of information, dialog with the Panel, and consideration of comments from SWRCB and CDPH staff on this draft report, which was prepared by the Panel and provides the results from the deliberations.

The Panel was provided with a summary of CDPH concerns (Appendix 1-2). The Panel reviewed and discussed the CDPH summary and developed the following list of priority questions that it felt were within the Panel's charge. A brief response to each question is shown below. More detailed information is contained in Sections 3 and 4 of this report.

Question 1: How to characterize acceptable (safe) recycled water for irrigation?

Using a peer-reviewed quantitative microbial risk assessment (QMRA) model, the Panel considered and developed estimated median annualized risks of infection for the three agriculture water reuse scenarios and treatment processes shown in Table E-1 (See Section 3.0 for a detailed

discussion). As shown, the QMRA results are based on conservative assumptions, including daily exposure and a 7-day environmental decay of pathogens prior to harvesting. The results of the QMRA indicate that annualized median risks of infection for full tertiary treatment (i.e., treatment that meets the requirements in the California Title 22 Water Recycling Criteria for Disinfected Tertiary Recycled Water) range from 10^{-8} to 10^{-4} (for human enteric viruses as estimated by enterovirus, *Cryptosporidium parvum* and *Giardia lamblia*, and *Escherichia coli* O157:H7, based on the assumptions noted in Table E.1, which includes daily exposure). Assuming that crops will be irrigated with recycled water only 8 percent of the time (approximately 30 days per year) by the year 2030¹ results in risks that are an order of magnitude lower (i.e., 10^{-9} to 10^{-5}). It is important to note that the estimated risks are for infection rather than disease, and that not all infections result in clinical disease (Pipes [1978] estimated that one of every 100 infections may result in disease).²

Table E.1 Scenarios for Agricultural Reuse, Treatment, and Conservative Exposure Assumptions

Scenario	Agricultural Use	Treatment	Conservative Exposure Assumptions
One (I)	Food crops (edible portion in contact with water)	Disinfected Tertiary	Average daily consumption of lettuce per body weight: 0.205 g/kg-day; Body weight: lognormal distribution with mean 61.4 and SD 13.4 kg; Volume of water on lettuce: zero-truncated normal distribution with mean 0.108 and SD 0.02 mL/g; 7-day environmental decay ^a
Two (II)	Orchards and Vineyards (no contact with edible portion of crops)	Undisinfected Secondary	0.1 mL/day, assumes daily exposure and consumption ; 7-day environmental decay ^a
Three (III)	Food crops (edible portion above ground – no contact)	Disinfected Secondary, 2.2 MPN/100 mL	0.1 mL/day, assumes daily exposure and consumption ; 7-day environmental decay ^a

a) Over a 7-day decay period, a mean 3.3-log reduction for enterovirus, 3-log reduction for *E. coli*, and 2-log reduction for *Giardia* and *Cryptosporidium* were assumed.

g/kg-day = grams per kilogram per day

mL/g = milliliters per gram

mL = milliliter kg = kilogram

MPN = most probable number

SD = standard deviation

mL/day = milliliters per day

Several sensitivity analyses were explored. Except where noted, all sensitivity analyses were performed for enterovirus with tertiary treatment and direct application to edible crops (see Scenario I).

¹ See Section 2.1.1 for a discussion on the 8-percent assumption (adjusts the daily exposure to approximately 30 days per year).

² In addition, Pipes et al. (1978) notes that not all infections result in disease, and that the transition to clinical disease depends on a number of factors, including the virulence of the pathogen.

- The first sensitivity analysis considered that not all exposures over the year are likely to be to crops irrigated with recycled water. As described in Section 2.1, projections suggest that recycled water may be applied to approximately 8 percent of crops by 2030. Adjusting the daily exposure rate by the 8-percent assumption (approximately 30 days of exposure) results in the adjusted annualized median risks for Scenario 1 that are approximately one order of magnitude lower (i.e., ranging from 10^{-5} to 10^{-9}) than the risks, assuming exposure to recycled water-irrigated crops every day.
- Second, a sensitivity analysis was performed on the numbers of days of environmental decay of pathogens (i.e., 7 versus 14 days) and an alternative decay rate (i.e., normal distributed k with a mean of 1.07 and an SD of 0.07 [zero truncated] as described by Petterson et al. [2001, 2002]) from Asano et al. (1992) of $k=0.69$ was considered. The risk results are highly sensitive to environmental decay assumptions, varying by 4 to 6 orders of magnitude, depending on the assumption used. The Panel assumed that 7 days of environmental decay was reasonable and appropriate based on practical experience and best professional judgment as opposed to a 14-day period. Thus, over a 7-day decay period, a mean 3.3-log reduction for enterovirus, 3-log reduction for *E. coli*, and 2-log reduction for *Giardia* and *Cryptosporidium* were assumed.
- Third, a sensitivity analysis was performed on the treatment efficacy. In this analysis, a single point estimate of log removal was specified to generate annualized risk. Risks vary across a wide range because a wide range of treatment efficacies were considered. Generally, each additional log removal results in approximately one order of magnitude lower annual risk.
- Finally, for Scenarios II and III, which consider applications of reclaimed water to non-edible portion of crops, an alternative exposure assumption that was one order of magnitude lower was considered (an ingestion volume of 0.01 milliliter per day [mL/day]). The annualized risk estimates, therefore, are approximately one order of magnitude lower risks than their higher exposure counterparts.

In summary, the sensitivity analyses suggest linear sensitivities to treatment efficacy (one order of magnitude risk per one log removal) and especially large sensitivities with respect to environmental decay assumptions (4 to 6 orders of magnitude in risk). The risk results are relatively insensitive to days of exposure (1.5 orders of magnitude). The Scenario II and III results are somewhat insensitive to exposure volumes assumed (one order of magnitude of risk for one order of magnitude lower volume).

The bottom line is that the median annualized risk estimates for infection are consistent with previous estimates relied on by CDPH to develop the Water Recycling Criteria³ and, as discussed below, provided the Panel with additional evidence to confirm the conclusion that current agricultural practices that are consistent with the criteria do not measurably increase

³ CDPH considers a 1 in 10,000 (i.e., 1×10^{-4}) mean risk of infection to be an acceptable risk from exposure to treated wastewater effluent (CDPH, 2010).

public health risk, and that modifying the standards to make them more restrictive will not measurably improve public health.

Question 2: What is the basis/support for the current assumption that “essentially pathogen free” is comparable to a 1 in 10,000 annual risk of infection? Is this level of public health risk and the associated assumptions appropriate for agricultural irrigation associated exposures? If not, what are appropriate assumptions regarding an acceptable/tolerable public health risk?

Evaluating the adequacy of a particular treatment train requires a benchmark level (or set of criteria) that can be used for comparison. The selection of a benchmark level of acceptable or tolerable risk (or *de minimis* level) is a complicated process that involves evaluating technical, political, and social factors, which is outside of the Panel’s charge. However, to provide input and guidance to CDPH on this subject, the Panel utilized a weight-of-evidence approach that considered available information on four key factors (See Section 3.6 for further discussion):

- Current regulatory examples of acceptable and/or tolerable risk.⁴
- CDPH historical background information and assumptions regarding public health risk associated with developing recycled water standards.
- Past and current QMRAs for recycled water.
- Comparison of estimated public health risk to U.S. diarrheal disease incidence rates.

Based on the weight-of-evidence, the Panel provides the following statements regarding two key questions:

1. Should CDPH develop an “acceptable” or “tolerable” risk metric for applications included in the Water Recycling Criteria? Based on this Panel’s review and analysis, the Panel does not believe at this time that developing an acceptable or tolerable risk metric is warranted.
2. Is there any evidence that the current treatment-based requirements in the Water Recycling Criteria increase the risk to public health through the irrigation of food crops with recycled water? The Panel’s review of the available weight-of-evidence, including past (Tanaka et al., 1998; Olivieri et al., 2007) and current (Section 3.0) QMRA results, confirms that the current agricultural practices consistent with the Water Recycling Criteria do not measurably increase public health risk, and that modifying the standards to make them more restrictive will not measurably improve public health.

Question 3: What is the basis for the current 5-log virus reduction criteria? Is the criterion still relevant? If not, how should it be modified (including potential indicator organism)?

⁴ CDPH implementation of the Water Recycling Criteria is based on a goal that the treatment-based standards provide sufficient overall plant reliability to achieve the U.S. Environmental Protection Agency’s (EPA’s) Surface Water Treatment Rule (SWTR) (i.e., potable drinking water) acceptable risk goal of one infection per 10,000 people per year based on enteric viruses (or *de minimis* level).

and

Question 4: What is the basis for the 450 milligram-minutes per liter (mg-min/L) concentration × time (CT) chlorine disinfection criteria? Is this CT level appropriate and if not, how should it be modified?

1. Based on seeded polio virus studies on tertiary treatment using direct filtration (Pomona Virus Study [Sanitation Districts of Los Angeles County, 1977] and Monterey Wastewater Reclamation Study for Agriculture [Engineering-Science, 1987]) and other data from operational water reclamation facilities in California, the Panel concurs with the CDPH 1999 finding that – for irrigation of food crops eaten raw – requiring a CT of 450 mg-min/L for disinfected tertiary recycled water (or a 5-log inactivation/removal of poliovirus or MS2 coliphage⁵ through filtration and disinfection) is appropriate. This is not meant to imply that alternative treatment technologies and/or different CTs would not ensure adequate health protection; however, studies would be needed to document that an equivalent level of health protection would be provided by the alternative treatment technologies or CTs (e.g., see Finding 2 below).
2. The CT requirement specified in the Water Recycling Criteria principally is based on the Pomona Virus Study, which used combined chlorine, a modal contact time of about 90 minutes, and seeding with Poliovirus I. It would be worthwhile for the water industry to commission a follow-up study to determine whether the use of free chlorine at different modal contact times would be able to achieve 5 logs of seeded virus removal at lower chlorine contact times, thus resulting in lower CT requirements.⁶
3. The Panel recognizes that drinking water regulations allow a lower CT to demonstrate 5 log of virus removal, but is of the opinion that it is inappropriate to use drinking water CT criteria for recycled water because recycled water is a more complex medium in terms of its microbial makeup (owing to its proximal wastewater origin) than drinking water, and a safety factor is needed for prudent added public health protection.

Question 5: How should multi-barrier treatment and effectiveness be defined? How should it be evaluated?

A simple approach to a multiple barrier is to provide a process train of multiple units that provides a high level of performance such that the treatment train can meet the overall removal goal even if the most effective single unit process fails. However, generally, this approach is not useful for most nonpotable uses of recycled water, since disinfection is the key step in the treatment of recycled water for such uses, and total failure of the disinfection process will almost always result in product water that does not meet microbial requirements. A better approach is to focus on the reliability and control of the disinfection process.

⁵ Please note that achieving a 5-log reduction by relying on MS2 is not feasible based on available data (see Question 4 in Section 4.1). MS2 is more resistant to combined chlorine than poliovirus.

⁶ It would be useful for CDPH to review the elements of such a study as described in the WateReuse Research Foundation (WRRF) report (WRF-03-01) by Darby et al., 2006.

Question 6: Is the current <2 nephelometric turbidity units (NTU) (average daily) turbidity criteria still a valid filtration performance standard? If not, how should it be modified?

1. The Panel agreed that the turbidity requirements specified in the Water Recycling Criteria for wastewater that has received media filtration are adequate.
2. While the Panel understands the rationale for the more restrictive turbidity requirements where membranes are used in place of media filters, the Panel noted that more information is required to document the need for the low turbidity requirements when membranes are used in place of media filters. For example, it would be important to find out whether membrane treatment that produces wastewater meeting a turbidity limit of 2 NTU indicates that more pathogens are present in the wastewater before disinfection than that for media filtration meeting the same turbidity limit.

Question 7: Should performance standards be used to define/characterize secondary treatment? If yes, how should they be described?

1. For the next revision of the Water Recycling Criteria, the Panel recommends that the term “oxidized wastewater” be replaced with “stabilized wastewater” and that numerical limits are connected to the term “stabilized wastewater.” The U.S. Environmental Protection Agency (EPA) secondary treatment numerical limits would be logical values. “Stabilized” is a more inclusive and accurate term when considering emerging technologies and the goals of wastewater treatment. Newer technologies (e.g., low-pressure membrane treatment) will allow physical-chemical treatment of primary effluent and will also allow for anaerobic biological treatment. Both of these treatment approaches can have significant advantages over traditional aerobic biological treatment with respect to energy use and energy recovery from the residual solids. These emerging process approaches may eventually meet numerical limits for secondary treatment, but may not meet the current definition of oxidized wastewater. A change in terminology would allow for developing and future process trains to be more easily accepted into use if the effluents from these process trains meet specified water quality limits.
2. Until the recycling criteria are revised, the above-finding can be implemented by CDPH via use of Section 60320.5 (other methods of treatment) in the Water Recycling Criteria. This section states: “Methods of treatment other than those included in this chapter and their reliability features may be accepted if the applicant demonstrates to the satisfaction of the State Department of Health that the methods of treatment and reliability features will assure an equal degree of treatment and reliability.”

Question 8: Are total coliforms still an appropriate indicator of overall disinfection performance? If not, how should it be modified?

The answer is a qualified yes. The use of coliforms as indicators of the sanitary quality of water has had a successful history for more than a century, with particular application to monitoring drinking water. The public health experience in the evaluation of the safety of wastewater effluents, especially in protecting water recreationists in direct contact with recycled water, has

been positive. The use of recycled water for unrestricted food crop irrigation has less of a history, but experience to date has also been positive. A low level of total coliforms in treated effluents has proven to be an adequate indicator of the performance (reduction of microbial agents) by an entire treatment process. The ability of a wastewater treatment plant to consistently produce water that meets the total coliform standards has been the key to the protection of public health.

At this point in time, we have no practical and time-proven alternative to the coliform standard. Subsets of the total coliform group have been suggested as being more indicative of sanitary quality (i.e., fecal coliform and *E. coli*, for which recognized assay methods are available). The total coliforms are the most conservative indicator of plant performance, followed closely by fecal coliform and *E. coli*, in that order.

New indicator assay and identification methods are being developed but, thus far, they are not practical for routine monitoring, nor have they been shown to be superior to the coliform culture standard. The regulatory agencies should keep abreast of and carefully evaluate developments in this area.

Question 9: Do crops take up pathogenic viruses? If yes, is this route of exposure a public health concern for agriculture irrigation with recycled water?

The potential presence of human pathogens in recycled water and their uptake (internalization) into plant tissue via the root system, leaf stoma, etc. were raised as potential concerns. There is evidence that internalization may occur under laboratory conditions with exposure to a high concentration of pathogens. The most realistic scenario is the attachment of microbial pathogens to plant surfaces in such a way that processing sanitization or other intervention is less effective. This latter scenario is the probable mechanism of contamination associated with recent outbreaks (e.g., see a more detailed discussion under Question 9 in Section 4.1 and in Baert et al., 2011), none of which were associated with the use of recycled water for irrigation.

There are no definitive links to any outbreaks or sporadic illness associated with the irrigation of California produce with recycled wastewater, nor with recycled water used extensively in Florida for irrigation. Monterey County recycled wastewater used for irrigation of leafy greens and other produce is a local example of the use of recycled wastewater for an extended period without any known links to human illness.

Future Investigations

As part of the review of the Water Recycling Criteria, the Panel recommends that CDPH investigate addressing the following topics to refine and augment current criteria:

1. Because turbidity readings do not necessarily correlate with disinfection performance, it is recommended that CDPH should undertake a comprehensive study to assess the benefits of incorporating particle size and distribution as a performance measure for filters used for recycled water applications. Ultimately, it is envisioned that the turbidity requirement would be augmented with a requirement based on particle size distribution.

2. Because the use of free chlorine can offer significant advantages over the use of combined chlorine, it is recommended that CDPH undertake a comprehensive study of the required CT values based on free chlorine for wastewater treatment processes that nitrify completely. Ultimately, it is envisioned that the required CT values would be based on the wastewater treatment technology, process control, and process monitoring instrumentation. As part of developing the scope for this recommended investigation, CDPH should review the 2006 WateReuse Research Foundation document entitled, “Pathogen Removal and Inactivation in Reclamation Plants – Study Design” (Darby et al., 2006).

References

- Asano, T., L.Y.C. Leong, M.G. Rigby, and R.H. Sakaji (1992). “Evaluation of the California Wastewater Reclamation Criteria Using Enteric Virus Monitoring Data.” *Water Sci. Technol.*, 26:1513.
- Baert, L., K. Mattison, F. Loisy-Hamon, J. Harlow, A. Martyres, B. Lebeau, A. Stals, E. Van Coillie, L. Herman, and M. Uyttendaele (2011). “Review: Norovirus Prevalence in Belgian, Canadian, and French Produce: A Threat to Human Health?” *Int. J. Food Microbiol.*, 151: 261-269.
- California State Water Resources Control Board (2009). *Recycled Water Policy. Resolution No. 2009-0011*, Sacramento, California.
- Darby, J., A. Olivieri, C. Tang, and A. Salveson (2006). *Pathogen Removal and Inactivation in Reclamation Plants – Study Design (WRF-03-001)*, WateReuse Research Foundation, Alexandria, Virginia.
- Engineering-Science (1987). *Monterey Wastewater Reclamation Study for Agriculture: Final Report*. Prepared for the Monterey Regional Water Pollution Agency by Engineering-Science, Berkeley, California.
- Olivieri, A.W., E. Seto, and J. Soller (2007). *Application of Microbial Risk Assessment Techniques to Estimate Risk Due to Exposure to Reclaimed Waters (WRF-04-001)*. WateReuse Research Foundation, Alexandria, Virginia.
- Petterson, S. R., N. J. Ashbolt, et al. (2001). "Microbial risks from wastewater irrigation of salad crops: A screening-level risk assessment." *Water Environment Research*: 667-672.
- Petterson, S. R., N. J. Ashbolt, et al. (2002). "Of: Microbial risks from wastewater irrigation of salad crops: A screening-level risk assessment." *Water Environment Research*: 411.
- Pipes, W.O. (1978). *Water Quality and Health Significance of Bacterial Indicators of Pollution*, Drexel University, Philadelphia, Pennsylvania.
- Sanitation Districts of Los Angeles County (1977). *Pomona Virus Study: Final Report*. Prepared by the Sanitation Districts of Los Angeles County for the California State Water Resources Control Board, Sacramento, California.
- Tanaka, H., T. Asano, E.D. Schroeder, and G. Tchobanoglous (1998). “Estimating the Safety of Wastewater Reclamation and Reuse Using Enteric Virus Monitoring Data.” *Water Environ. Res.*, 70(1): 39-51.

Yamamoto, G.H., (2010) California Department of Public Health letter to Assistant Executive Officer K.D. Landau, central valley Water Board, June 15, 2010.

1.0 INTRODUCTION

Water quality standards and treatment reliability criteria for water recycling are contained in the CDPH Water Recycling Criteria (Title 22, Division 4, Chapter 3, of the California Code of Regulations). Because of adherence to these criteria, the use of recycled water for agricultural food crop irrigation has a history of safe use in California. However, improved knowledge of wastewater treatment effectiveness, changes in agricultural practices, and increased knowledge of the behavior of pathogens and disease has prompted a re-evaluation of California's Water Recycling Criteria. Therefore, CDPH convened an expert Panel *to consider whether recycled water produced in conformance with California's Water Recycling Criteria is sufficiently protective of public health for agricultural food crop irrigation.*

The scope of the review is limited to the irrigation of agricultural food crops (Table 1.1) and excludes urban and residential irrigation, irrigation of non-food agricultural crops (such as turf, seed, fiber, and ornamental crops), and all non-irrigation uses. Further, the review is limited to exposure to waterborne pathogens of concern from the irrigation of a wide variety of food crops requiring different recycled water qualities, as noted below.

Table 1.1 Agriculture Irrigation Reuse Option and Required Treatment

Agricultural Use	Treatment
Orchards and vineyards (no contact with edible portion of crops)	Undisinfected Secondary
Food crops (edible portion above ground – no contact)	Disinfected Secondary, 2.2 MPN/100 mL
Food crops (edible portion in contact with water)	Disinfected Tertiary

The following is a list of the potential CDPH topics presented to the Panel for consideration:

- Public health objectives and structure of the criteria.
- Available risk assessment information, including exposure assessment and hazard characterization.
- Filtration requirements, including the turbidity performance standard, acceptable filter designs, filter loading rate, and treatment optimization.
- Disinfection requirements, including the coliform performance standard, CT required for chlorination, and log reduction goal for virus and protozoan parasites (*Cryptosporidium* and *Giardia*).
- Use area crop handling, irrigation practice assumptions, and other best management practices.
- Treatment reliability requirements.
- Monitoring requirements.
- Role of multi-barrier treatment.

1.1 The NWRI Independent Advisory Panel

Recognizing that consideration of the exposure to microbial pathogens and their potential effects on human health is a significant concern, and that regulatory requirements need to be based on best available science, CDPH and SWRCB included a provision in the Recycled Water Policy (California State Water Resources Control Board, 2009) to establish an expert Panel.

The NWRI Independent Advisory Panel for the Review of California’s Water Recycling Criteria for Agricultural Irrigation was formed in February 2008 and is administered by the National Water Research Institute (NWRI), a nonprofit research organization. Nine members make up the Panel, including academics, public agency representatives, independent consultants, and water industry representatives. They are nationally recognized experts in the fields of public health microbiology and virology, quantitative microbial risk assessment, public health infectious diseases and epidemiology, water reuse, food safety and hazard analysis, agricultural practices, irrigation management, contaminants of emerging contaminants, and water and wastewater treatment effectiveness (as seen in Table 1-2). The Panel has over 150 years of combined experience investigating water reuse and potential public health issues.

The Panel has significant expertise with California’s Water Recycling Criteria, and has a wide range of experience nationally and internationally. Panel member qualifications were assembled by NWRI and reviewed by CDPH staff prior to final selection.

Table 1.2 Panel Members

Area of Expertise	Name	Affiliation
Public Health/Microbiology Virology	<i>Panel Chair:</i> Robert C. Cooper, Ph.D.	University of California, Berkeley
Microbial Risk Assessment	<i>Vice Chair:</i> Adam W. Olivieri, Dr.P.H., P.E.	EOA, Inc.
Irrigation Management of Food Crops and Microbial Food Safety	Michael D. Cahn, Ph.D.	University of California, Cooperative Extension
Public Health/Epidemiology	John M. Colford, Jr., M.D., Ph.D., M.P.H.	University of California, Berkeley
Water Reuse	James Crook, Ph.D., P.E.	Water Reuse Consultant
Contaminants of Emerging Concern	Jean-François Debroux, Ph.D.	Kennedy/Jenks Consultants
Food Safety/Hazard Analysis Critical Control Point	Robert Mandrell, Ph.D.	U.S. Department of Agriculture
Agricultural Practices and Contaminant Controls	Trevor Suslow, Ph.D.	University of California, Davis
Water Treatment Effectiveness	George Tchobanoglous, Ph.D., P.E., NAE	University of California, Davis

A brief biography of each Panel member is provided in Appendix 1-1.

While the Panel was formed in 2008, it did not begin work until the spring of 2010. Over the past 2 years, the Panel held four meetings, a number of subcommittee meetings, and numerous conference calls. The Panel meetings included the opportunity for stakeholder input in clarifying the Panel’s charge, exchange of information, dialogue with the Panel, and consideration of comments from SWRCB and CDPH staff on this draft report, which was prepared by the Panel and provides the results from deliberations.

1.2 Charge to the Panel

The Panel was provided with a summary of a number of CDPH concerns (Appendix 1-2). The Panel reviewed and discussed the CDPH summary and developed the following list of priority questions that it felt were within the Panel's charge:

1. How to characterize acceptable (safe) recycled water for irrigation?
2. What is the basis/support for the current assumption that "essentially pathogen free" is comparable to a 1 in 10,000 annual risk of infection? Is this level of public health risk and the associated assumptions appropriate for agricultural irrigation associated exposures? If not, what are appropriate assumptions regarding an acceptable/tolerable public health risk?
3. What is the basis for the current 5-log virus reduction criteria? Is the criterion still relevant? If not, how should it be modified (including potential indicator organism)?
4. What is the basis for the 450 mg-min/L CT chlorine disinfection criteria? Is this CT level appropriate and, if not, how should it be modified?
5. How should multi-barrier treatment and effectiveness be defined? How should it be evaluated?
6. Is the current <2 NTU (average daily) turbidity criteria still a valid filtration performance standard? If not, how should it be modified?
7. Should performance standards be used to define/characterize secondary treatment? If yes, how should they be described?
8. Are total coliforms still an appropriate indicator of overall disinfection performance? If not, how should it be modified?
9. Do crops take up pathogenic viruses? If yes, is this route of exposure a public health concern regarding agricultural irrigation water recycling?

1.3 Organization of the Report

This report contains five sections and associated appendices. Section 1 describes the Panel's charge and key questions that the Panel addressed. Section 2 describes the current and projected levels of water recycling in California, the regulatory framework, an overview of microbial pathogens of concern, and a brief summary of epidemiological evidence of infectious disease incidence associated with water recycling. Section 3 provides the results of the QMRA conducted for this report and a weight-of-evidence discussion of acceptable public health risk. Section 4 contains the Panel's review of key questions related to performance standards and the question of equivalency, and Section 5 contains the Panel's findings and recommendations.

Reference

California State Water Resources Control Board (2009). *Recycled Water Policy. Resolution No. 2009-0011*, Sacramento, California.

2.0 CALIFORNIA WATER REUSE AND PUBLIC HEALTH REGULATIONS

The purpose of this section is to provide a brief summary of the following:

- California levels of water recycling.
- SWRCB and CDPH water reuse regulations and guidance.
- Overview of microbial pathogens and public health concerns.
- Available information on water recycling epidemiological studies.

2.1 California Water Recycling

Water reclamation, recycling, and reuse are integral components of water resource planning and management in California. In the past, the driving motivation for water recycling was to supplement scarce resources and to provide a means of avoiding effluent disposal into surface waters. With increased water demand brought on by continued drought and increasing population, recycled wastewater is now considered an important water resource. Nonpotable and potable recycled water can enable communities to maximize and extend the use of limited water resources.

The use of appropriately treated wastewater as alternative and/or supplemental water sources for potable uses includes applications such as:

- Landscape irrigation (e.g., parks, golf courses, residential).
- Agricultural irrigation (e.g., crops, commercial).
- Industrial uses (e.g., cooling towers, construction).
- Urban nonpotable (e.g., toilet flushing, firefighting).
- Recreational/environmental uses (e.g., lakes, marshes, stream flow augmentation).

In addition, adequately treated wastewater can be used for supplementing drinking water supplies, as is the case in currently approved projects that recharge groundwater for indirect potable use.

2.1.1 Current Levels of Water Reuse and Future Resource Demands

For nearly a century, recycled water has been used intentionally as a nonpotable water supply source in California. The implementation of reclamation projects has increased significantly over the years, even in the face of regulatory, economic, and social constraints. In 1989, the reuse of municipal wastewater in California was estimated at 325,000 acre-feet per year.⁷ In 2002, the SWRCB conducted a comprehensive statewide survey of municipal facilities that focused on documenting the current levels of nonpotable reuse of treated municipal wastewater. The results of the 2002 survey indicated that, as of the end of 2001, approximately 525,460 acre-feet per year of recycled water was used in California (State Water Resources Control Board, 2011). More recent SWRCB data indicate that, during 2009, approximately 669,000 acre-feet

⁷One acre-foot is equivalent to approximately 325,851 gallons of water.

per year of recycled water was used (State Water Resources Control Board, 2012). A summary of the statewide survey is shown in Figure 2.1, suggesting that the top three reuses are for agricultural uses (37 percent), landscape irrigation (17 percent), and groundwater recharge and seawater intrusion barrier uses (19 percent). At present, estimates indicate that about 8 to 10 percent of municipal wastewater is recycled in planned reuse projects. Estimates regarding future recycling indicate that California has the potential to recycle an additional 1.4 to 1.6 million acre-feet per year of water by the year 2030 (Smith, 2010).

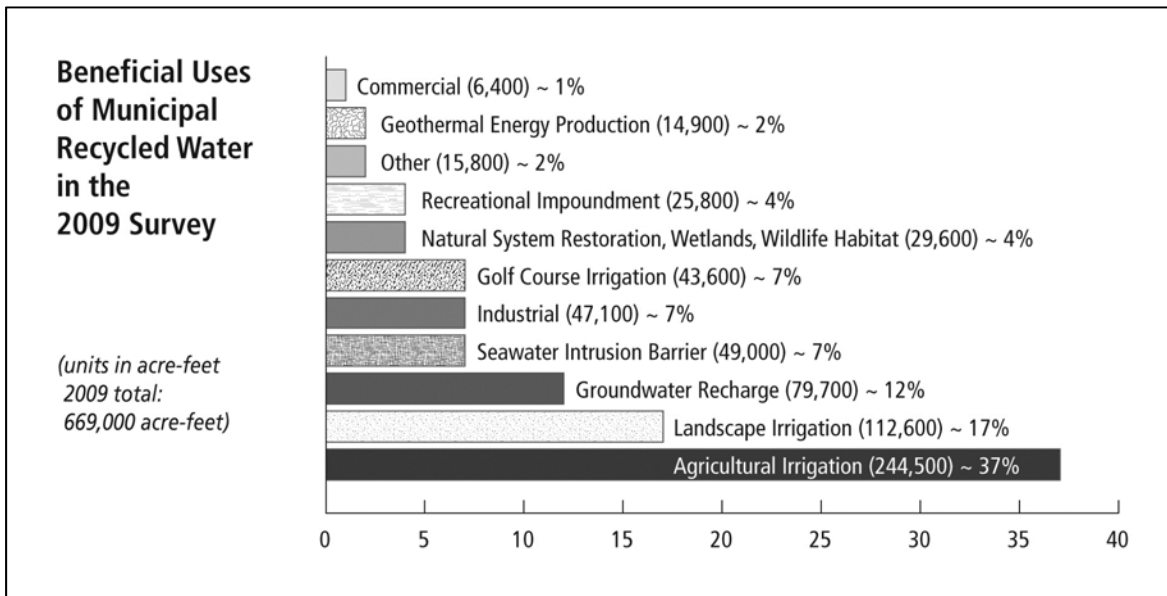

Figure 2.1 Types of wastewater reuse in California as a percentage of annual use (2009)
(Source: State Water Resources Control Board, 2012).

2.1.2 Agricultural Irrigation Reuse

Agricultural reuse in California represents a large percentage of the total recycled water in the state: approximately 37 percent (or roughly 240,000 acre-feet per year). Agricultural reuse in California can be further divided into six main categories (U.S. EPA, 2004):

- Mixed (approx. 16 percent of total reuse).
- Harvested feed, fiber, and seed (approx. 14 percent).
- Pasture (approx. 4 percent).
- Orchards and vineyards (approx. 1 percent).
- Food crops (approx. 1 percent).
- Nursery and sod (approx. 1 percent).

Estimated future demand, as noted above, could increase agricultural reuse by a factor of 3.2 to 3.5 times current reuse levels by 2030.⁸

⁸ Current estimates indicate that approximately 2 percent of edible food crops are irrigated with reclaimed water and, based on a linear extrapolation, estimated food crop use could increase to 8 percent.

2.2 SWRCB and CDPH Regulations/Guidance and Relationship

For recycled water to be used safely, there are several necessary regulatory controls, which include:

1. Clear, effective, and appropriate standards (which is the focus of this Panel review).
2. An effective regulatory structure (which is outside the scope of this Panel review, but is briefly discussed below and in Appendix 2-1).
3. Proper operation and oversight by the permitted agency to ensure that the irrigation is being conducted properly and consistent with State regulations (which is outside the scope of this Panel review).
4. Regulatory oversight of the agricultural products and field operations (which is outside the scope of this Panel review).

Recycled wastewater in California is mainly regulated by the following state agencies: CDPH, SWRCB, and the nine Regional Water Quality Control Boards (RWQCBs). The State and Regional Water Boards have the primary responsibility for the protection and enhancement of the waters of the State. SWRCB also has the primary responsibility for administering water rights. CDPH has the authority and responsibility to establish public health criteria for wastewater reclamation, including groundwater recharge, and reviews all proposals and plans for such projects throughout the State. Local health agencies and water districts can develop policies and programs that are more stringent than those specified by CDPH.

State statutes and regulations pertaining to the recycling of treated wastewater in California can be found in the California Water Code (CWC), California Health and Safety Code, and the California Code of Regulations (CCR). Water quality control plans (Basin Plans) may also contain the recycled water use policy of individual RWQCBs. The CDPH Water Recycling Criteria governing the production and use of recycled water are contained in Title 22, Division 4, of the CCR (State of California, 2000). A summary of the CDPH criteria is presented in Table 2.1. A more detailed discussion is contained in Appendix 2-1.

As noted in Table 2.1, specific treatment processes have been relied on in California to significantly reduce the numbers of viruses and parasites (i.e., a process or performance standard rather than a strict pathogen standard). Specifically, the regulations include process standards for crop irrigation (unrestricted) to ensure that the recycled water has a total coliform concentration of less than or equal to 2.2 MPN per 100 milliliters (mL). Water meeting these criteria is considered safe for human contact, and is based on the past experience of health professionals and on a lack of detectable health problems associated with agricultural irrigation (National Research Council, 1996).

**Table 2.1 Summary of California Department of Public Health
Water Reuse Treatment Requirements**

Purpose of Use	Treatment Requirement
Orchards and vineyards (no contact with edible crops), nonfood-bearing trees, fodder or fiber crops, seed crops (not eaten by humans), food crops (with additional pathogen treatment for crop), and flushing sanitary sewers.	Undisinfected Secondary ^a
Cemeteries, freeway landscaping, golf courses (restricted access), ornamental nursery stock, sod farms, pasture (milk animals), non-edible vegetation (controlled access), commercial/industrial cooling towers (with drift reduction), landscape impoundments (no decorative fountains), industrial boiler feed, soil compaction, mixing concrete, dust control (roads), cleaning roads, nonstructural firefighting.	Disinfected Secondary, 23 MPN/100 mL ^b
Food crops (edible portion above ground – no contact), restricted recreational impoundments.	Disinfected Secondary, 2.2 MPN/100 mL ^c
Food crops, parks and playgrounds, school yards, residential landscaping, golf courses (unrestricted), commercial/industrial cooling towers (mist devices), unrestricted recreational impoundments (with specific pathogen monitoring), flushing toilet and urinals, structural firefighting, decorative fountains, artificial snow making, commercial car washes, groundwater recharge (with additional treatment –see CDPH draft groundwater regulations).	Disinfected Tertiary ^d

Notes:

- a) **Undisinfected secondary treatment:** means oxidized wastewater (oxidized wastewater: wastewater in which the organic matter has been stabilized, is non-putrescible, and contains dissolved oxygen).
- b) **Disinfected secondary – 23 MPN per 100 mL recycled water:** oxidized and disinfected so that the median concentration of total coliform bacteria does not exceed a most probable number of 23 MPN per 100 mL, and the MPN does not exceed 240/100 mL in more than one sample in any 30-day period.
- c) **Disinfected secondary – 2.2 MPN per 100 mL recycled water:** oxidized and disinfected so that the median concentration of total coliform bacteria does not exceed a most probable number of 2.2/100 mL, and the MPN does not exceed 2/100 mL in more than one sample in any 30-day period.
- d) **Disinfected tertiary recycled water:** a filtered and disinfected wastewater (see definition below) that meets a CT (product of total chlorine residual and modal contact time measured at the same point) value of not less than 450 mg-min/L at all times, with a modal contact time of 90 minutes (min.) (based on peak dry weather design flow) or provides a 5-log removal/reduction of MS2 F-specific phage or poliovirus or similar virus.

Filtered wastewater: an oxidized, coagulated, clarified wastewater that has been passed through natural undisturbed soils of filter media, such as sand or diatomaceous earth, so that the turbidity, as determined by an approved laboratory method, does not exceed 5 turbidity units more than 5 percent of the time during any 24-hour period, an average of 2 NTU during a 24-hour period, and does not exceed a 10 NTU at any time; in addition, the filter may not exceed 5 gallons per min. per square foot (traveling bridge automatic backwash filters cannot exceed 2 gallons per min.).

Source: Summary adapted from the State of California, 2000.

2.3 Overview of Microbial Pathogens and Public Health Concerns

Water recycling is becoming an increasingly common component of water resource planning. Thus, people may raise the question, “What human health effects are associated with the use of reclaimed wastewater effluent for nonpotable purposes?” The following discussion provides a brief summary of public health concerns about water-related infectious disease agents associated with nonpotable uses (e.g., landscape irrigation, agricultural irrigation for food crops) of recycled water. Water-related infectious diseases (waterborne) include those diseases for which water acts only as the passive vehicle for the infectious agents (Saunders and Warford, 1976).

A fundamental requirement of all water reclamation programs is to assure that public health is not compromised. The presence of pathogenic microorganisms in untreated wastewater creates the potential for adverse health effects where there is contact, inhalation, or ingestion of the microbiological agents of concern. The objective is to reduce potential adverse health effects and keep them below acceptable levels. In general, the public health risk is in proportion to the extent and reliability of the wastewater treatment provided and the degree of human contact with the treated water. Therefore, the protection of public health is accomplished by:

- Reducing the concentration of pathogenic agents in the wastewater through treatment, including disinfection; and
- Limiting exposure through the implementation of management practices.

2.3.1 Pathogenic Microorganisms

The infectious disease agents associated with municipal wastewater are those found in the domestic sanitary waste of the population. These microbial pathogens include bacteria, viruses, and parasites. A summary of the important water-related microbial agents is included in Table 2.2. In addition, a brief description of the characteristics of the various categories of microbial agents is provided below.

Bacterial Pathogens

Bacteria are microscopic organisms that range in size from 0.2 to 10 micrometers (μm). Fecal material contains many types of harmless bacteria that colonize the human intestinal tract. A large portion of fecal weight is bacterial biomass. One group of intestinal bacteria, the coliform bacteria, has historically been used as an indicator organism to address fecal pollution by wastewater and as an assessment of wastewater treatment plant performance. In domestic wastewater, the fecal coliform concentration may constitute 30 to 40 percent of the total coliforms. Most strains of *E. coli* present in the gastrointestinal tract of humans and warm-blooded animals are harmless; however, there are multiple pathogenic types of *E. coli* that have been identified. The types of *E. coli* that cause the most cases of diarrhea are enterotoxigenic, enteropathogenic, and enteroinvasive *E. coli*. These strains represent a small percentage (approximately 2 to 8 percent of the coliforms found in water) of the total concentration of *E. coli* organisms. As shown in Table 2.2, other species of important pathogens may be present in human feces and transmittable via the water route (i.e., those associated with gastroenteritis, diarrhea).

Table 2.2 Water-Related Infectious Agents

Organism	Disease/Symptom
Bacterial: <i>Salmonella</i> spp. <i>Shigella</i> spp. <i>Vibrio cholera</i> <i>Vibrio parahaemolyticus</i> <i>Campylobacter jejuni</i> Enteropathogenic <i>E. coli</i> <i>Yersinia enterocolitica</i>	Typhoid, paratyphoid Bacillary dysentery Cholera Gastroenteritis Gastroenteritis, paralytic disease (rare) Gastroenteritis, hemolytic uremic syndrome Gastroenteritis
Enteric Viruses: Enteroviruses (polio-, Coxsackie-A and B, Echo-, Hepatitis A) Rotavirus Adenovirus Norovirus Astrovirus	Paralysis, meningitis, respiratory illness, myocarditis, Gastroenteritis, infectious hepatitis Gastroenteritis Respiratory illness, gastroenteritis Gastroenteritis Gastroenteritis
Protozoa: <i>Giardia lamblia</i> <i>Entamoeba histolytica</i> <i>Cryptosporidium</i> spp.	Diarrhea Amoebic dysentery Diarrhea

Sources: Adapted from Feachem et al. (1983) and Bitton (1994).

Viral Pathogens

Viruses are obligate intracellular infectious agents that are incapable of replication outside a host organism. Enteric viruses replicate in the human intestinal tract and are shed in the fecal material of infected individuals. They range in size from approximately 25 to 350 nanometers (nm) and, therefore, can only be observed with an electron microscope. There are over 100 known varieties of human enteric viruses, not all of which have been determined to cause water-related infections or disease. Some of the more important waterborne enteric viruses are listed in Table 2.2. There is no evidence that the human immunodeficiency virus (HIV), the pathogen that causes the acquired immunodeficiency syndrome (AIDS), can be transmitted via a waterborne route (Riggs, 1989).

Protozoan Parasites

Most protozoan parasites produce cysts or oocysts that are life-cycle resting stages that can survive outside their host under adverse environmental conditions. In general, protozoan parasitic cysts are larger than bacteria. They range in size from 2 μm to 15 μm . Both symptomatic and non-symptomatic individuals excrete protozoan cysts or oocysts. Protozoan parasites are similar in nature to viruses in that they do not reproduce outside the host organism (i.e., in the environment). The major waterborne protozoan parasites affecting humans are listed in Table 2.2.

2.3.2 Infectious Disease Transmission

To produce infectious disease in a population, three conditions (criteria) are necessary: (1) the disease agent must be present, (2) the disease agent must be present in sufficient concentration to be infectious, and (3) susceptible individuals must come into contact with the agent in a manner that causes infection and disease (Cooper, 1991a).

Criterion 1

From a public health perspective, it is wise to assume that raw wastewater contains pathogenic organisms; thus, the first condition is always met. The concentration of these agents in wastewater is a function of disease prevalence in the community. Typical concentrations of some of the pathogenic microorganisms found in raw wastewater are shown in Tables 2.3 through 2.5.

Criterion 2

Human dose-response data for specific pathogens is required to address the second criterion. Although some data are available, they are limited and require careful interpretation when used to estimate effects at the population level. The available dose response data clearly indicate that it typically takes more than a single pathogenic microorganism to produce disease and, in many cases, low doses produce infection rather than disease. The nature of the severity of responses is variable, as documented in the literature (Bryan, 1974). Some examples of the dose of pathogens required to produce disease in 25 to 75 percent of the exposed individuals are noted below in Table 2.6.

Criterion 3

The third criterion (and final link) in the infectious disease transmission chain is the exposure of the susceptible human population to infectious agents. The most common route of exposure to wastewater-associated pathogens is by ingestion, although other routes, such as respiratory and eye, can be involved.

Therefore, while it is important to consider all three criteria when evaluating the potential public health risk of any water reuse operation, if treated wastewater is to be recycled, there is a greater need to reduce the pathogen numbers to levels low enough to minimize the possibility of a public health problem prior to use of the water.

Table 2.3 Summary of Literature Review for Enteric Virus Mean Concentrations in Wastewater Treatment Process Effluent (Units in MPN/100 L)^a

Source	Influent	Secondary ^b	Filtered	Disinfected w/Chlorine	Original Units
Rose et al., 2004 ^c	9E+03	4E+01	6E+00	1E+00	MPN/100 L
Rose et al., 1996	1E+03	2E+01	3E+00	3E-01	PFU/100 L
Cooper et al., 1997	2E+03			3E-01	PFU/100 ML
Buras, 1976	1E+07				PFU/100 ML
Funderburg and Sorber, 1983	6E+03	5E+02			PFU/L
Grabow et al., 1980	1E+04	2E+03	5E+02	ND(Ozone)	Count/10 L
Irving and Smith, 1981	1E+05	1E+04			IU/L
Leong et al., 1983		1E+02			PFU/L
Leong et al., 1989		4E+00	1E-01		MPN/378 L
Lewis et al., 1986	2E+04				PFU/L
Morris, 1984	1E+06				PFU/L
Schwartabrod et al., 1985	4E+03	6E+02			PFU/L
Rose and Gerba, 1991		1E+02	1E-01	1E+00	PFU/100 L
Rolland et al., 1983a; 1983 ^d	1E+03	2E+02			PFU/L
Rao et al., 1981	1E+05				PFU/L
Payment et al., 1986	1E+04	1E+02			MPN IU/L
Sedmak et al., 2005	1E+05			5E+02	
MRWPCA data (1997-2010)				<1 - <4	TC/100 L (n=53)
MRWPCA data (1997-2010) ^e				<.1 - <.2	TC/100 L (n=26)
Bambic et al., 2011 ^f	2E+06	6E+04			PFU/100 ML
Orange County Water District data (1978-1981) ^g		2E+00			PFU/100 L (GM)
MRWPCA data (1980-1985) ^g		2E+02			PFU/100 L (GM)
Sanitation Districts of Los Angeles County (Pomona) data (1975) ^g		6E+00			PFU/100 L (GM)
Las Virgines Municipal Water District (1975) ^h		2E+00			PFU/100 L (GM)
CDPH (San Jose Creek/Whittier Narrows) data (1987) ⁱ	2.6E+4	2E+01		5E-02	PFU/1000 gal (median)
Gray et al., 2009; Konnan et al., 2009 ^f	1E+02			1.6E+02	PFU or MPN/L

Notes:

- Data represent information from treatment plants in Australia, Southern California, Central Coast of California, Florida, Texas, South Africa, Israel, France, and Arizona.
 - Secondary treatment means activated sludge plants.
 - Overall, n equals 32-33 samples across six plants and unit process.
 - The summary assumes that all methods are comparable, and that measurement units can be directly converted to MPN estimates.
 - Detection level change data from MRWPCA (2010).
 - Dry weather operation (Geometric Mean, or "GM").
 - Adapted from California Department of Health Services (1991) and Tanaka et al. (1998).
 - Adapted from California Department of Health Services (1991).
 - Adapted from Department of Public Health (1987).
- MPN = Most probable number.
L = Liter

Table 2.4 Summary of Literature Review for *Cryptosporidium* Mean Concentrations in Wastewater Treatment Process Effluent (Units in total oocysts/100 L)

Source	Influent	Secondary	Filtered	Disinfected
Rose et al., 2004 ^a	6E+03	1E+02	7E+01	3E+01
McCuin and Clancy, 2006	6E+02	3E+02		
Rose et al., 1996 ^a	1E+03	1E+02	4E+00	2E+00
Cooper et al., 1997	2E+02		4E-01	
Rose and Gerba, 1991			5E+00	
MRWPCA data (1997- 2010) ^b		6E+1		
Sacramento Regional Wastewater Treatment Plant data (1997/2002, 2011) ^c		8E+02		
MRWPCA data (1997) ^d	7E+03	4E+01	2E+00	
Bambic et al., 2011 ^e	1E+06	6E+02	6E+00	
Gray et al., 2009; Konnan et al., 2009 ^f	1E+02	NA	None	5E+02

Notes:

- a) Infectious oocysts ranged from 0 to 25 percent of samples tested. Overall, n equals 32-33 samples across six plants and unit process.
- b) Effluent is disinfected. N equals 57 with 28 samples detected and the remainder ND. Mean values based on ND values set to ND. Data from MRWPCA (2010).
- c) No infectious information, n equals 65. Effluent is disinfected. Reported 80-percent detection in samples. 2011 data excerpted from Sacramento Regional Wastewater Treatment Plant (SRWTP) process control data spreadsheet dated June 6, 2011, per H.L. Ramil. 1997/2002 data adapted from Central Valley Water Board administrative draft anti-degradation analysis dated May 2009.
- d) N equals 7 for raw and secondary and 6 for disinfected filtered. Filtered value is based on average detection level; none were detected. Adapted from California Department of Health Services (1991) and Tanaka et al. (1998).
- e) Water Environment Research Foundation (WERF) literature review. Secondary effluent is disinfected.
- f) Dry weather operation (Geometric Mean, or “GM”) – non infective.

Table 2.5 Summary of Literature Review for *Giardia* Mean Concentrations in Wastewater Treatment Process Effluent (Units in total cysts/100 L)

Source	Influent	Secondary	Filtered	Disinfected
Rose et al., 2004 ^a	1E+05	1E+03	9E+01	8E+01
Rose et al., 1996	7E+03	4E+02	4E+00	1E+00
Cooper et al., 1992	2E+04			
Cooper et al., 1997	3E+04		1E+00	
Sykora et al., 1991	1E+05	2E+03		
Roach et al., 1993	1E+05			
Enriquez et al., 1995		2E+01		
Rose and Gerba, 1991			8E+01	
MRWPCA data (1997- 2010) ^b		4E+01		
Sacramento Regional Wastewater Treatment Plant data (1997/2002, 2011) ^c		4E+03		
Bambic et al., 2011 ^d	3E+03	1E+03	4E+02	
MRWPCA data (1997- 2010) ^e	1E+06	6E+02	6E+00	
Gray et al., 2009; Konnan et al., 2009 ^f	3E+05	NA	None	1E+03

- a) Overall, n equals 32-33 samples across six plants and unit process.
- b) Effluent is disinfected. N equals 56 with 13 samples detected and the remainder ND. Mean values based on ND values set to ND. Data from MRWPCA, 2010. N equals 61.
- c) Effluent is disinfected. Reported 100-percent detection in samples. 2011 data excerpted from Sacramento Regional Wastewater Treatment Plant (SRWTP) process control data spreadsheet dated June 6, 2011, per H.L. Ramil. 1997/2002 data adapted from Central Valley Water Board administrative draft anti-degradation analysis dated May 2009.
- d) Water Environment Research Foundation (WERF) literature review.
- e) N equals 7 for raw and secondary and 5 for disinfected filtered. 100 percent of cysts were empty and noted as non-human based on anti-body reagent. Data from MRWPCA, 2010.
- f) Dry weather operation.

Table 2.6 Dose of Pathogens Required for 25 to 75 Percent Illness (Disease or Infection) Response in Humans

Organism	Dose (Number of Organisms)
<i>Salmonella</i> spp.	100,000 to 1,000,000,000 organisms
<i>Salmonella typhi</i>	1,000 to 10,000,000 organisms
<i>Giardia lamblia</i>	1 to 100 cysts
Enteroviruses	1 to 100 plaque-forming units (PFUs)
<i>E. coli</i> (pathogenic)	100,000 to 10,000,000 organisms
<i>E. coli</i> O157:H7	50 to 50,000,000 organisms ^a
<i>Cryptosporidium</i> spp.	3 to 14 oocysts ^b

Sources: Bryan, 1974; Feachem et al., 1983; Bitton, 1994; Rowe and Abdel-Magid, 1995.

- a) Based on *E. coli* O157 dose-response function (Teunis et al., 2004) (approximated by beta-poisson distribution).
- b) Based on the mean of the dose response parameter range, r=uniform [0.04, 0.16].

2.4 Summary of Epidemiological Evidence of Infectious Disease Incidence Associated with Water Reuse

Epidemiological studies of exposed populations at water reuse sites that use disinfected recycled water treated to relatively high levels are difficult to conduct. Factors such as population mobility (particularly as it relates to other non-waterborne sources of these pathogens), the ability to measure low levels, if any, of health effects, and determining exposure levels limit the ability to conduct such studies. Thus, epidemiological studies have focused on a number of parameters and endpoints, including wastewater-contaminated drinking water supplies, the use of raw or minimally treated wastewater for food crop irrigation, health effects to farm workers who routinely come in contact with poorly treated wastewater, health effects associated with wastewater treatment plant workers, and the exposure to and health effects associated with aerosols from spray irrigation (U.S. EPA, 2004).

A number of studies dating back to 1931 have documented evidence of infectious disease transmission from practices associated with the consumption of uncooked vegetables irrigated with untreated and poorly treated wastewater (e.g., Khalil, 1931; Lund, 1980; Shuval et al., 1984; Blumenthal et al., 2000). In addition, a more recent critical review of selected epidemiological studies of wastewater and excreta use in agriculture was reported by Blumenthal and Peasey (2002), again documenting the above conclusions and further noting that wastewater treatment markedly reduced the risk of helminth infections related to the consumption of wastewater-irrigated crops. A 1992 study in St. Petersburg, Florida, showed helminths were completely removed in secondary clarifiers (Rose and Carnahan, 1992). Excluding the use of raw and poorly treated wastewater, the EPA (as well as other respected research organizations) notes that there is no evidence of confirmed cases of infectious disease resulting from the use of recycled wastewater in the United States where such uses have been in compliance with public health regulations (U.S. EPA, 2004; Water Pollution Control Federation, 1989).

Further, the most extensive literature available on human exposure to wastewater addressed the risk of infectious disease to wastewater treatment plant operators and maintenance personnel. A review of that literature indicates that the occurrence of clinical disease associated with occupational exposure among these workers is rarely reported, although infections of new workers have occurred prior to the build-up of immunity (Cooper, 1991b). It is important to note that wastewater treatment plant operators are potentially exposed to much higher concentrations than individuals potentially exposed to disinfected tertiary recycled water.

References

- Bambic, D., McBride G., Miller, W., Scott, R., and Wuertz, A. (2011). Quantification of Pathogens and Sources of Microbial Indicators for QMRA in Recreational Waters, WERF, PATH2R08.
- Bitton, G. (1994). *Wastewater Microbiology*, Wiley-Liss, New York, N.Y.
- Blumenthal, U.J., and A. Peasey (2002). *Critical Review of Epidemiological Evidence of the Health Effects of Wastewater and Excreta Use in Agriculture*, London School of Hygiene and Tropical Medicine, England.

- Blumenthal, U.J., Peasey, A., Guillermo, R., and Mara, D. (2000). *Guidelines for Wastewater Reuse in Agriculture and Aquaculture: Recommended Revisions based on New Research Evidence, Task No. 68 (1)*, London School of Hygiene and Tropical Medicine, England.
- Buras, N., Concentration of enteric viruses in wastewater and effluent: A two year survey. *Water Research*, 1976, 10, 295-98.
- Bryan, F.L. (1974). *Diseases Transmitted in Food Contaminated with Wastewater*. U.S. Environmental Protection Agency, EPA 660/2-74-041, Washington, D.C.
- California Department of Health Services (1991). Excerpts from Environmental management Branch, Draft Statement of Reasons Relating to Risk of Exposure to Reclaimed Water Used other than for groundwater Recharge, December 10, 1991.
- Department of Public Health, Executive Summary (1987). Wastewater Disinfection for Health protection, February 1987.
- California Department of Public Health (2008). *Groundwater Recharge Reuse DRAFT Regulation, August 5, 2008*. California Department of Public Health, Drinking Water Program, Sacramento, California.
- Cooper, R.C. (1991a). Public Health Concerns in Wastewater Reuse. *Water Sci. Technol.* 24(9):55.
- Cooper, R.C. (1991b). *Disease Risk among Sewage Plant Operators: A Review. Sanitary Engineering and Environmental Health Research Laboratory Report No. 91-1*. University of California, Berkeley.
- Cooper, R.C., Olivieri, A.W., Eisenberg, D.M., Danielson, R.E., Pettegrew, L.A., Fairchild, W.A., and Sanchez, L.A., *San Diego Aqua II Pilot Plant Health Effects Study*. 1992.
- Cooper, R.C., Olivieri, A.W., Eisenberg, D.M., Soller, J.A., Pettegrew, L.A., and Danielson, R.E. *Total Resource Recovery Project Aqua III San Pasqual Health Effects Study Final Summary Report*; Western Consortium for Public Health: 1997.
- Enriquez, V., Rose, J.B., Enriquez, C.E., and Gerba, C.P. (1995). Occurrence of *Cryptosporidium* and *Giardia* in secondary and tertiary wastewater effluents. In *Protozoan Parasites and Water*. (ed. W.B. Betts, Casemore, D., Fricker, C. R., Smith, H., and Watkins, J., eds.), pp. 84-86. The Royal Society of Chemistry, Cambridge, England.
- Feachem, R.O., Bradley, O.I., Garelick, H., and Mara, D.O. (1983). *Sanitation and Disease: Health Aspects of Excreta and Wastewater Management*, The World Bank, Washington, D.C.
- Funderburg, S., and Sorber, C. (1983). *Bacteriophages as Indicators of Human Enteric Viruses in Activated Sludge, CRWR-199*; Texas University, Center for Research in Water Resources: Austin, Texas.
- Gray, D., Shang, Y., Hake, J., DeLange, V., Chien, M., Gardner, E., Konnan, J., and Grinbergs, S. (2009). *Characterizing the Quality of Effluent and Other Contributory Sources during Peak Wet Weather Events*, WERF, 03-CTS-12PP/PPa.
- Grabow, W.O.K., Burger, J.S., and Nupen, E.M., Evaluation of acid-fast bacteria, *Candida albicans*, enteric viruses and conventional indicators for monitoring wastewater

- reclamation systems. *Prog. Water Technol* 1980, 12, 803-17.
- Irving, L.G., and Smith, F.A., One-Year Survey of Enteroviruses, Adenoviruses, and Reoviruses Isolated from Effluent at an Activated-Sludge Purification Plant. *Applied and Environmental Microbiology*, 1981, 51-59.
- Khalil, M. (1931). The pail Closet as an Efficient Means of Controlling Human Helminth Infections as Observed in Tura Prison – Egypt, *Annals of Tropical Medicine and Parasitology* 25, 35-62.
- Konnan, J., Olivieri, A., and Seto, E. (2009). *Microbial Risk Assessment of Human Health Impacts Associated with Water Contact Recreation during Wastewater Treatment Plant Blending*, prepared for EBMUD and WERF (03-CTS-12PP/PPa).
- Leong, L.Y.C., Argo, D.G., and Trussell, R.R., Enterovirus Removal By A Full-Scale Tertiary Treatment Plant. *Journal American Water Works Association* 1983, 75, (4), 199-204.
- Leong, L.Y.C., Colbaugh, J.E., Stokes, H.W., and Leong, C.J., Fate of microorganisms in a tertiary Treatment System. *Wat. Sci. Tech.* 1989, 20, (11/12), 445-47.
- Lewis, G.D., Austin, F.J., Loutit, M.W., and Sharples, K., Enterovirus removal from sewage. *Water Res* 1986, 20, (10), 1291-97.
- Lund, E. (1980). *Health Problems Associated with the Re-Use of Sewage: I. bacteria, II. Viruses, III. Protozoa and Helminths*. WHO Working papers for Seminar on Health Aspects of Treated Sewage Reuse. Algiers.
- McCuin, R.M., and Clancy, J.L., Occurrence of Cryptosporidium oocysts in US wastewaters. *J Water Health* 2006, 4, (4), 437-52.
- Morris, R., Reduction of naturally occurring enteroviruses by wastewater treatment processes. *J Hyg. (Lond)* 1984, 92, (1), 97-103.
- Monterey Regional Water Pollution Control Agency (MRWPCA) Compiled SVRP and CSIP Data from 1997 through 2010, personal communication Bob Holden, 2010.
- National Research Council (1996). *Use of Reclaimed Water and Sludge in Food Crop Production*, National Academy Press, Washington, D.C.
- Payment, P., Fortin, S., and Trudel, M., Elimination of Human Enteric Viruses During conventional Waste Water Treatment By Activated-Sludge. *Canadian Journal of Microbiology* 1986, 32, (12), 922-25.
- Rao, V.C., Lakhe, S.B., and Wahgmare, S.V., Virus removal in waste stabilization ponds in India. *Water Res* 1981, 15, (7), 773-78.
- Riggs, J.L. (1989). AIDS Transmission in Drinking Water: No Threat. *Journal AWWA*, 83(11):76-84.
- Roach, P.D., Olson, M.E., Whitley, G., and Wallis, P.M., Waterborne Giardia cysts and Cryptosporidium oocysts in the Yukon, Canada. *Appl Environ Microbiol* 1993, 59, (1), 67-73.
- Rolland, D., Hartemann, P., Joret, J.C., Hassen, A., and Foliguet, J.M., Evaluation of The Load of Enteroviruses In A Biological Wastewater Treatment-Plant. *Water Science and Technology* 1983a, 15, (5), 115-21.

- Rolland, D., Joret, J.C., Villeval, F., Block, J.C., and Hartemann, P., Sampling Strategy for Detecting Viruses in a Sewage Treatment Plant. *Applied and Environmental Microbiology* 1983b, 46, (6), 1767-74.
- Rose, J., Dickson, L., Farrah, S., and Carnahan, R., Removal of pathogenic and indicator microorganisms by a full-scale water reclamation facility. *Water Res.* 1996, 30, (11), 2785-97.
- Rose, J.B., Haas, C.N., and Regli, S., Risk assessment and control of waterborne giardiasis. *Am J Public Health* 1991, 81, (6), 709-13.
- Rose, J.B., Nowlin, H., Farrah, S.R., Harwood, V., Levine, A., Lukasik, J., Menendez, P., and Scott, T.M., Reduction of pathogens, indicator bacteria, and alternative indicators by wastewater treatment and reclamation processes. *Water Environment Research Foundation Report 00-PUM 2T*, 2004.
- Rose, J.B., and Carnahan, R.P. (1992). *Pathogen Removal by Full Scale Wastewater Treatment. A Report to the Florida Department of Environmental Protection*. University of South Florida. Tampa, Florida.
- Rowe, D.R., and Abdel-Magid, I.M. (1995). *Handbook of Wastewater Reclamation and Reuse*, Lewis, Publishers, CRC Press, Inc., Boca Raton, Fl.
- Saunders, R.J., and Warford, I.J. (1976). *Village Water Supply*, The John Hopkins University Press, London, U.K.
- Schwartabrod, L., Vilagines, P., Schwartabrod, J., Sarrette, B., Vilagines, R., and Collomb, J., Evaluation of the viral population in two wastewater treatment plants. *Water Res* 1985, 19, (11), 1353.
- Sedmak, G., Bina, D., MacDonald, J., and Couillard, L., Nine-year study of the occurrence of Culturable viruses in source water for two drinking water treatment plants and the influent and effluent of a wastewater treatment plant in Milwaukee, Wisconsin (August 1994 through July 2003). *Applied and Environmental Microbiology* 2005, 71, (2), 1042-50.
- Shuval, H.I., Yekutieli, P., and Fattal, B. (1984). Epidemiological Evidence for Helminth and Cholera Transmission by Vegetables Irrigated with Wastewater: Jerusalem – A Case Study, *Water Science and Technology*, 17, 433-442.
- Smith, D. (2010). Personal communication with David W. Smith, Ph.D., Managing Director, WaterReuse California (Sacramento, CA).
- State of California (2000). *Water Recycling Criteria. California Code of Regulations, Title 22, Division 4, Chapter 3*. California Department of Health Services, Sacramento, California.
- State Water Resources Control Board (2011). The California Water Boards' Annual Performance Report – 2010.
http://www.waterboards.ca.gov/about_us/performance_report_1011/plan_assess/12513_ww_recycling.shtml.
- State Water Resources Control Board (2012). *Municipal Wastewater Recycling Survey*.
http://www.waterboards.ca.gov/water_issues/programs/grants_loans/water_recycling/mu

[nirec.shtml](#).

Sykora, J.L., Sorber, C.A., Jakubowski, W., Casson, L.W., Gavaghan, P.D., Shapiro, M.A., and Schott, M.J., Distribution Of Giardia Cysts In Waste-Water. *Water Science and Technology* 1991, 24, (2), 187-92.

Tanaka, H., Asano, T., Schroeder, E. D., and Tchobanoglous, G. (1998). "Estimating the safety of wastewater reclamation and reuse using enteric virus monitoring data." *Water Environ Res*, 70(1), 39-51.

Teunis, P., Takumi, K., and Shinagawa, K. (2004). Dose response for infection by *Escherichia coli* O157:H7 from outbreak data. *Risk Anal* 2004, 24, (2), 401-7.

U.S. Environmental Protection Agency (2004). *Guidelines for Water Reuse*, U.S. Agency for International Development, EPA-265/R-03/108, Cincinnati, Ohio.

Water Pollution Control Federation (1989). *Water Reuse* (Second Edition) - Manual of Practice SM-3. WPCF, Alexandria, Virginia.

3.0 PUBLIC HEALTH RELEVANCE OF MICROBIAL PATHOGENS IN RECYCLED WATER TO HUMAN HEALTH

The purpose of this section is to present:

- Pathogens of public health concern for agricultural water reuse.
- Microbial risk assessment methodology and its assumptions.
- Findings of the microbial risk assessment for agricultural reuse.
- Sensitivity of the findings to assumptions.
- A discussion of acceptable or tolerable risk.

3.1 Pathogens of Public Health Concern

When considering the infectious disease implications of human exposure to raw (as well as treated) wastewater, the following factors need to be considered: (1) for waterborne illness or disease to occur, an agent of disease (pathogen) must be present; (2) the agent must be present in sufficient concentration to produce disease (dose); and (3) a susceptible host must come into contact with the dose in a manner that results in infection or disease (Cooper et al., 1986; Cooper, 1991).

Although a wide range of pathogens have been identified in raw wastewater, relatively few types of pathogens appear to be responsible for the majority of the waterborne illnesses caused by pathogens of wastewater origin (Mead et al., 1999). The pathogens of public health concern, based on foodborne disease in the U.S., were identified by the Centers for Disease Control (CDC) (Mead et al., 1999). In characterizing food-related illness and death in the United States, Mead and co-workers estimated the annual total number of illnesses caused by known pathogens, adjusted for the fact that many illnesses are not reported, at 38.6 million cases – with 5.2 million cases (13.5 percent) from bacterial pathogens, 2.5 million cases (6.5 percent) from parasitic pathogens, and 30.9 million cases (80 percent) from viral pathogens. Noroviruses (provisionally known as Norwalk-like viruses) have been reported to account for 23,000,000 illnesses each year, of which 60 percent are estimated to be non-foodborne. Rotavirus accounts for 3,900,000 illnesses each year, of which 99 percent are non-foodborne (Mead et al., 1999). With this background, it follows that many of these pathogens find their way into domestic wastewater.

Review of the CDC research data approximates that 85 to 90 percent of all non-foodborne cases (i.e., cases related to other routes of transmission such as waterborne) in the United States are thought to be caused by viral pathogens (i.e., enteric viruses). The relative importance of viral pathogens in waterborne transmission of disease is supported by data from the World Health Organization (WHO) (World Health Organization, 1999) and by research conducted over the last 20 years on exposure to waterborne pathogens through recreational activities (Cabelli, 1983; Fankhauser et al., 1998; Levine and Stephenson, 1990; Palmateer et al., 1991; Sobsey et al., 1995; Wade et al., 2003).⁹

⁹ As part of defining “tolerable” risk, WHO has placed an emphasis on incorporating the concept of adjusting life years based on disability (i.e., considering severity and duration of a disease/infection allows shifting from parasites to viruses as the waterborne pathogen of concern).

3.2 Pathogens of Public Health Concern for Agricultural Reuse on Food Crops

From the long list of possible pathogens, those known to be present in wastewater, the major waterborne pathogens listed in Table 2.2, CDC's estimated disease burden in the United States, and those where water recycling plant performance and exposure data may exist, the following list comprises the suggested "pathogens of public health concern" for this project:

- Human enteric viruses as estimated by enterovirus occurrence in recycled water and rotavirus dose response (representative of human viruses).
- *Cryptosporidium parvum* and *Giardia lamblia* (representative of protozoa).
- *E. coli* O157:H7.

In addition, several other organisms of interests include adenovirus and noroviruses. However, for reasons noted below, these pathogens were not investigated as part of this analysis.

- Adenoviruses¹⁰ were discussed with the Panel, and adenovirus data were ultimately not analyzed for this report due to the discrepancy between the dose-response relationship and the route of exposure considered for this study of agricultural reuse. The existing dose-response data and mathematical relationship (Couch et al., 1966; Crabtree et al., 1997) apply to inhalation and, thus, may not be applicable to the exposure routes considered.
- Norovirus was not explicitly analyzed because a comparison of the dose-response relationship for norovirus (Teunis et al., 2008) with rotavirus indicates that use of the rotavirus dose-response was more conservative (i.e., health protective) with respect to estimating the risks from enteric viruses.

¹⁰ Adenoviruses were first recognized by Rowe et al. (1953) while they searched for the cause of the common cold. Mena and Gerba (2008) make the following points about adenovirus:

- Currently, there are some 51 human adenovirus serotypes that are divided into six subgenera.
- Routes of infection include the mouth, nasopharynx, and ocular conjunctiva, and illnesses include upper and lower respiratory illnesses, conjunctivitis, cystitis, and gastroenteritis, with disease outbreaks generally associated with day care centers, children's camps, hospitals, and other healthcare facilities.
- Several investigations have reported that adenovirus is second only to rotavirus as the causative agent of gastroenteritis in infants and young children; however, most illnesses appear to be acute and self-limiting.
- Serotypes Ad40 and 41 tend to be associated with gastroenteritis; however, because all serotypes besides the enterics are excreted in feces (i.e., roughly one-third are associated with human disease), contaminated water may be a source of exposure.
- While no recreational receiving water or recycled water outbreaks of enteric adenovirus have been reported, several outbreaks associated with swimming pools and drinking water have occurred.
- Adenoviruses are commonly detected in raw wastewater, and both enteric and respiratory adenoviruses have been detected throughout the world in surface waters.

Foy (1997) has noted that it is difficult to link adenovirus to specific illnesses because asymptomatic, healthy people can shed the virus. Based on some limited studies, adenovirus sensitivity to oxidizing agents appears to be equal to or greater than other enteric viruses (e.g., Ad40 appears to be very sensitive to chlorine, CT of 2.4 for 4-log reduction at 2 degrees Celsius). However, adenoviruses, relative to enteric viruses, appear to be quite resistant to ultraviolet irradiation (Gerba et al., 2002; Mena and Gerba, 2008). Currently, dose-response data (i.e., Ad4) are only available for the inhalation route of exposure (Couch et al., 1966), and it is possible that the dose-response relationship for enteric adenovirus and ingestion via the water route at very different. EPA placed adenovirus on the federal drinking water contaminant candidate list (CCL) as an unregulated emerging contaminant.

3.3 Quantitative Microbial Risk Assessment

QMRA involves evaluating the likelihood that an adverse health effect may result from human exposure to one or more pathogens. It involves the selection of pathogens where literature demonstrates that exposure will likely result in disease, and selection of a model to calculate risks to an individual or population. A review of recent work conducted in the QMRA field indicates that calculating exposure to a limited number of pathogens is appropriate and will be conservative (public health protective), as discussed in the following sections. For risk assessment, two fundamental approaches are pervasive in the literature. They may be categorized as static, individual-based risk assessment, or dynamic, population-based risk assessments. Each of these approaches is discussed in the following sections.

Static Model

The static model (National Research Council, 1983) is commonly used as a generic framework for conducting MRAs of waterborne and foodborne pathogens (Crabtree et al., 1997; Farber et al., 1996; Hass et al., 1999, Sanaa et al., 2000; Voysey and Brown, 2000). Assessments using a static model typically focus on estimating the probability of infection or disease to an individual as a result of a single exposure event. These assessments generally assume that multiple or recurring exposures constitute independent events with identical distributions of contamination (Regli et al., 1991). Secondary transmission (e.g., person-to-person transmission) and immunity are assumed negligible or that they effectively cancel each other out. In actuality, secondary transmission would increase the level of infection/disease in a community relative to a specific exposure to pathogens, and immunity would decrease the level of infection/disease in a community relative to a specific exposure to pathogens (Soller et al., 2003a).

In the static model, it is assumed that the population may be categorized into two epidemiological states: a susceptible state and an infected or diseased state. Susceptible individuals are exposed to the pathogen of interest and move into the infected/diseased state with a probability that is governed by the dose of pathogen to which they are exposed and the infectivity of the pathogen. A schematic diagram of the static model is presented in Figure 3.1 (Colford et al., 2003). Early examples of this approach applied to recreational waters in the State of Illinois were conducted by Haas (1983) and in Southern California by Olivieri et al. (1986).

The epidemiological states represented in this static model are Susceptible and Infected/Diseased. The probability that a susceptible individual becomes infected or diseased is a function of the dose of pathogens to which that individual is exposed and the infectivity of the pathogen.

Although static models typically focus on estimating the risk per exposure event, in cases where the risk is expressed “per day,” the risk may be annualized:

$$P = 1 - (1 - \text{Probinf}(d))^n$$

Where P is the probability of being infected at least once during the year, Probinf(d) is the probability of being infected for a given daily dose d, and the number of days of exposure is n.

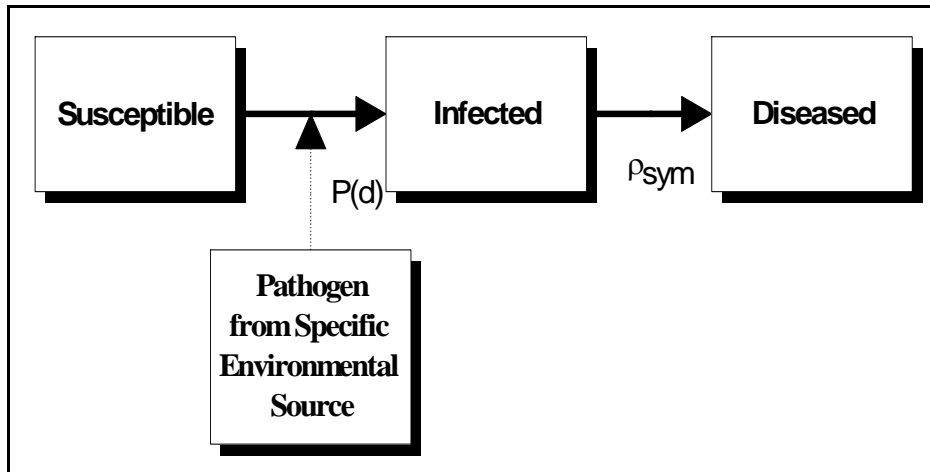

Figure 3.1 Static risk assessment conceptual model.

Dynamic Model

Another methodology that has been employed for MRAs is a dynamic model (Eisenberg et al., 1996a, b; Eisenberg et al., 1998; Olivieri et al., 1995a,b; Soller et al., 1999; Soller et al., 2003a,b,c; Soller et al., 2006; Gupta and Haas, 2004). In a dynamic risk assessment model, the population is assumed to be broken into a group of epidemiological states. Individuals move from state to state based on the natural history of the specific infectious disease (duration of infection, duration of immunity, etc.). Only a portion of the population is in a susceptible state at any point in time, and only those in the susceptible state can become infected or diseased through exposure to microorganisms.

In a dynamic model, the probability that a susceptible person moves into an exposed state is governed not only by the dose of the pathogen to which they are exposed and the infectivity of that pathogen, but also by the number of infected/diseased individuals with whom they may come into contact (Anderson and May, 1991; Hethcote, 1976). Because the infectious disease process in a population is fundamentally a dynamic process, the most rigorous approach for modeling the infectious disease process mathematically is to employ a dynamic model.

Recommended Microbial Modeling Approach

A static risk assessment approach was selected because of the available, but limited, information necessary for use of dynamic models (e.g., total number of diseased individuals, host immunity, etc.). This study's use of the static model employing Monte Carlo simulations in a comparative screening level risk characterization is consistent with the literature in the field describing conditions in which the use of the static model is appropriate (Cooper et al., 1986; Hass et al., 1983; Hass et al., 1999; Soller et al., 2004). Also, as part of the Water Environment Research Foundation (WERF) 2004 development of QMRA tools, the question of convergence using a dynamic versus the static model was investigated. The analysis indicated that, generally, as acceptable risk levels approached $<1/10,000$ per year for low doses, the static and dynamic model estimates were similar (Soller et al., 2004). A comparison of the models is provided in Table 3.1.

Table 3.1 Comparison of Static and Dynamic Risk Assessment Models

Static Risk Assessment Model	Dynamic Risk Assessment Model
Static representation.	Dynamic representation.
Direct exposure (environment-to-person).	Direct and indirect exposure (environment-to-person and person-to-person).
Individual-based risk.	Population-based risk.
Potential for secondary transmission of infection or disease is assumed to be negligible.	Potential for secondary or person-to-person transmission of infection or disease exists.
Immunity to infection from microbial agents is assumed to be negligible.	Exposed individuals may not be susceptible to infection or disease because they may already be infected or may be immune from infection due to prior exposure.
Dose-response function is the critical health component.	The dose-response function is important; however, factors specific to the transmission of infectious diseases may also be important, such as the duration of infection and immunity.

3.4 Quantitative Microbial Risk Assessment Approach

The general approach for this project was to utilize existing data and QMRA methods to derive a matrix of relative risks based on: combinations of specific pathogens that are representative of the pathogens most likely to be of public health concern; treatment processes that are representative of those currently used to produce recycled water used for irrigation of food crops; and relevant exposure routes based on food crop irrigation.

Data, for the purposes of this review, were obtained from the literature (see Section 2, Tables 2.3 through 2.5) to provide a representative characterization of the concentrations of the pathogens at various points in the wastewater treatment process and the expected levels of reductions of those pathogens through wastewater treatment for the treatment levels investigated.

Literature data were also used to estimate the volume of water ingested for each of the routes of exposure, as well as the relation between the number of organisms ingested (dose) and the probability of infection and/or illness (depending on the pathogen of interest). Numerical simulation (Monte Carlo simulation) was used to address variability and uncertainty in the computed estimates of risk. The QMRA simulations were conducted using the R language.¹¹ Static (individual-level) microbial risk assessment simulations were used as the base model. Risks were annualized according to the formula given above for annualized risk using the static modeling approach. Finally, the sensitivity of the model results to assumptions was explored.

Quantitative Microbial Risk Assessment Assumptions

The overall process by which risks were estimated for this investigation is illustrated in Figure 3.2.

¹¹ R is a system for statistical computation and graphics.

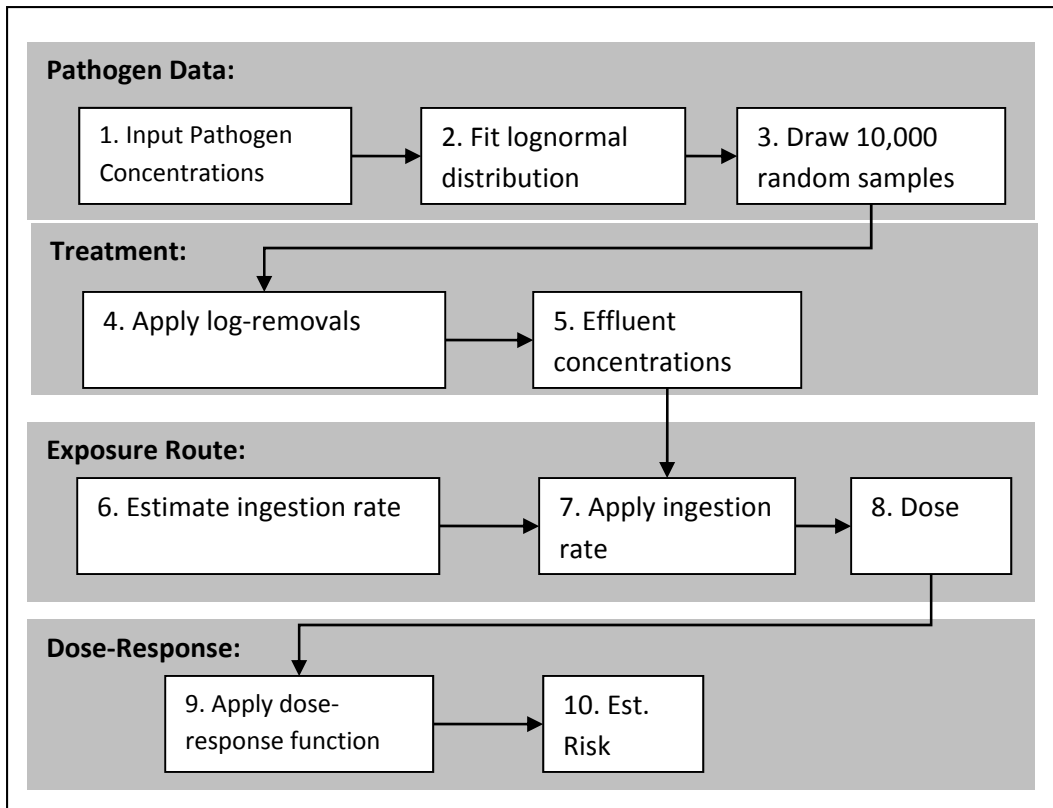

Figure 3.2 Flow diagram for conducting the microbial risk assessments.

For each pathogen/treatment process/route of exposure combination of interest, the following process was used. First, representative values were utilized to characterize the pathogen concentration in raw wastewater (1). The next step was to fit these data to a lognormal distribution (2) via the method of maximum likelihood (Ott, 1995; Olivieri et al., 1999). Statistical distributions were used rather than the actual raw data so that the effects of variability and uncertainty could be efficiently encapsulated in the resultant risk estimate. Reductions in the concentrations of the pathogens of interest that are expected to occur through wastewater treatment were estimated (3) and applied (4) to estimate effluent concentrations (5). Based on the exposure route of interest, ingestion rates were estimated (6). By combining the ingestion rate (7) with the effluent concentration, the dose of pathogen ingested per exposure event was estimated (8). A dose-response relationship, derived from the literature (9), was then used to estimate the risk associated with the dose for the exposure event and to estimate an annualized risk if the dose occurs throughout the year (10); the process was repeated 10,000 times to generate a distribution of estimated risk. Because all the dose-response functions for the pathogens considered have infection as an endpoint, the risk was expressed in terms of risk of infection.

Pathogen Concentrations in Untreated Wastewater and Recycled Waters

As introduced in Section 3.2, the waterborne pathogens of public health concern analyzed in this

investigation were the following:

- Human enteric viruses as estimated by enterovirus occurrence in reclaimed water and rotavirus dose response (representative of human viruses).
- *Cryptosporidium parvum* and *Giardia lamblia* (representative of protozoa).
- *E. coli* O157:H7 (representative of bacterial pathogens).

Data taken as representative of concentrations of each of the above pathogens in raw wastewater and secondary effluent were obtained from the literature. A bar graph summary of the relevant pathogen occurrence data from the literature is contained in Appendix 3-1.

The results of a comprehensive literature review, a previously-published WERF report (Rose et al. (2004)), was a key source of data used as input in this characterization of the potential risk associated with exposure to selected pathogens. In the investigation by Rose et al. (2004), six full-scale wastewater treatment and reclamation facilities in Arizona, California, and Florida were each monitored over a 1-year period for a variety of pathogens and indicator organisms. For the purposes of this evaluation, it is assumed that the six wastewater treatment facilities evaluated in the WERF investigation are representative of the types of reclamation facilities that are currently being employed in California. In addition, a comparison of the results of the brief literature review presented in Tables 2.3 through 2.5 and the Rose et al. data (also see Appendix 3-1) indicates that the Rose et al. data are appropriate to use for a representative characterization of the concentration of enteroviruses, *Cryptosporidium* spp., and *Giardia* spp. in both raw wastewater and secondary effluent.

The raw plant influent data employed as input for the QMRA simulations are included in Table 3.2 and are based on the Rose et al. (2004) data, as discussed above.

Data available to characterize *E. coli* O157:H7 concentrations in raw wastewater and secondary effluent were extremely limited. Quantitative data for *E. coli* O157:H7 in raw wastewater were reported by three research teams (Garcia-Aljaro et al., 2005; Heijnen and Medema, 2006; Muniesa et al., 2006). A summary of those data is provided in Table 3.3. The results reported by Garcia-Aljaro et al. (2005) were used as the basis for input to this QMRA.

Table 3.2 Summary of Raw Wastewater Pathogen Concentration Distributions Used for Modeling

Pathogen	Distribution
Enterovirus (MPN per L)	Lognormal (log mean 3.19, log SD 1.74) ^a
<i>Giardia lamblia</i> (cysts per L)	Lognormal (log mean 5.66, log SD 1.91) ^a
<i>Cryptosporidium parvum</i> (oocysts per L)	Lognormal (log mean 2.85, log SD 1.75) ^a
<i>E. coli</i> O157:H7 (organisms per L)	Uniform (min 0, max 5000) ^b

a) Based on Rose et al. (2004) data.

b) Based on Heijnen and Medema (2006) data.

Table 3.3 Table From Literature Review for *E. coli* O157:H7 (Units #/L)

Source	Influent Concentration	Notes
Heijnen and Medema, 2006	0-5000	Two samples below detection: one at 400, and one at 5000
Muniesa et al., 2006	100-1000	
Garcia-Aljaro et al., 2005	2×10^3	Based on eight samples, log (CFU)/ml =0.2 with sd=0.2

To rigorously account for the variability observed in pathogen concentrations in raw wastewater and secondary effluent, the pathogen concentration data summarized above were fit to lognormal probability distributions using Maximum Likelihood Estimation (MLE) (Ott, 1995), as shown in Figure 3.2. The lognormal distribution is a commonly used distributional form for environmental data fitting for concentrations of microorganisms in water (U.S. EPA, 1991). Ten thousand random samples from the lognormal MLE were generated and used in subsequent calculations.

The values shown in Table 3.4 are the expected log reductions due to the corresponding wastewater treatment processes.

Table 3.4 Summary of Pathogen Reductions through Wastewater Treatment Used in the Simulations (Units of Log Reduction)

Treatment	<i>Giardia</i> spp.		<i>Cryptosporidium</i> spp.		Rotavirus		<i>E. coli</i> O157:H7	
	Mean	SD	Mean	SD	Mean	SD	Mean	SD
Raw through disinfected secondary effluent	3.2	0.7	2.3	0.7	3.6	0.7	6.53	0.93
Secondary treatment through disinfected filtered effluent	1.0	0.6	0.8	0.5	1.3	0.6	4.2	1.3
Filtered secondary treatment through disinfection	0.2	0.2	0.2	0.3	0.6	0.5	2.0	1.4

Note: Normal distributions were zero truncated so that negative values were not sampled. Based on a re-analysis of the Rose et al. (2004) data.

These data are also taken from the report by Rose et al. (2004) and are considered to be representative values for purposes of this report. The values were generated by pairing concentrations taken at each plant at different stages of the treatment process based on rank order (e.g., pairing the highest influent concentration with the highest secondary treatment concentration, and pairing the highest influent concentration with the highest tertiary filtered disinfected concentration). A log reduction was generated for each set of paired concentrations. Shown are the mean and standard deviation of a normal distribution for the log reductions. The reduction of 1 log corresponds to 90-percent, the reduction of 2 logs corresponds to 99-percent reduction, etc. For *E. coli* O157:H7, the log reductions were estimated using fecal coliform data as a surrogate.

Two slightly different methods for estimating effluent concentrations via treatment were employed in this investigation. To estimate the concentrations of pathogens in disinfected secondary effluent, the estimated distributions of pathogen reductions across the disinfection unit process were used in conjunction with the reduction between secondary effluent and influent pathogen concentration distributions. To estimate the concentrations of pathogens in disinfected tertiary effluent, the estimated distributions of pathogen reductions from raw wastewater through filtered (tertiary) disinfected water were used in conjunction with raw wastewater concentration distributions.

For each set of simulations, 10,000 pathogen concentrations were sampled from the MLE lognormal distribution and the reduction distributions were subsequently multiplied. The products from these multiplications resulted in 10,000 estimated effluent concentrations (#/L). Additionally, a sensitivity analysis, in which treatment efficacy was set to fixed values from 1- to 8-log removal, was performed.

Route of Exposure via Food Crop Irrigation

The scope of the Panel's review of the Water Recycling Criteria applications, as discussed previously, is limited to irrigation of agricultural food crops and excludes urban and residential irrigation, irrigation of non-food agricultural crops (such as turf, seed, fiber, and ornamental crops), and all non-irrigation uses. Further, the QMRA is limited to the exposure to waterborne pathogens of concern from irrigation of a wide variety of food crops requiring different recycled water qualities, as noted below in Table 3.5. In addition, several assumptions regarding exposure must be made and are shown below as well.

For Scenario I, the method used to characterize human exposure through the irrigation of food crops is based on that described by Hamilton et al. (2006) and is consistent with earlier work conducted by other researchers in the field (van Ginneken and Oron, 2000; Petterson et al., 2001). The exposure approach is based on the assumption that the ingestion of recycled water is the product of three distributions: the rate of consumption of crops irrigated with recycled water (g/kg-day), body mass (kg), and volume uptake (mL/g). Lettuce consumption was used as the model crop for consumption because the consumption value is health protective relative to other vegetables (U.S. EPA, 2003). The consumption value for lettuce is a point estimate of 0.205 g/kg-day (U.S. EPA, 2003). Body mass is estimated by a lognormal distribution with mean of 61.429 and standard deviation of 13.362 kg (U.S. EPA, 1997). Volume uptake is estimated as a normal distribution with mean 0.108 and standard deviation of 0.02 mL/g (Hamilton et al., 2006).

The resultant distribution of ingestion volume (Figure 3.3); that is, the amount of irrigation water ingested via lettuce, has a median value of approximately 1.3 mL/day.

Because Scenarios II and III do not involve irrigation to the edible portion of the crop, we assumed an order of magnitude less exposure than the above lettuce case, and set exposure at 0.1 mL/day. At the request of the Panel, sensitivity analyses were performed on this by also considering a lower exposure rate of 0.01 mL/day.

Table 3.5 Agriculture Reuse, Treatment, and Exposure Assumptions

Scenario	Agricultural Use	Treatment	Exposure Assumptions
One (I)	Food crops (edible portion in contact with water)	Disinfected Tertiary	Average daily consumption of lettuce per body weight: 0.205 g/kg-day; Body weight: lognormal distribution with mean 61.4 and SD 13.4 kg; Volume of water on lettuce: zero-truncated normal distribution with mean 0.108 and SD 0.02 mL/g; 7-day environmental decay ^a
Two (II)	Orchards and Vineyards (no contact with edible portion of crops)	Undisinfected Secondary	0.1 mL/day, assumes daily exposure and consumption; 7-day environmental decay ^a
Three (III)	Food crops (edible portion above ground – no contact)	Disinfected Secondary, 2.2 MPN/100 mL	0.1 mL/day, assumes daily exposure and consumption; 7-day environmental decay ^a

a) Over a 7-day decay period, a mean 3.3-log reduction for enterovirus, 3-log reduction for *E. coli*, and 2-log reduction for *Giardia* and *Cryptosporidium* were assumed.

g/kg-day = grams per kilogram per day

kg = kilogram

mL/g = milliliters per gram

MPN = most probable number

mL = milliliter

SD = standard deviation

mL/day = milliliters per day

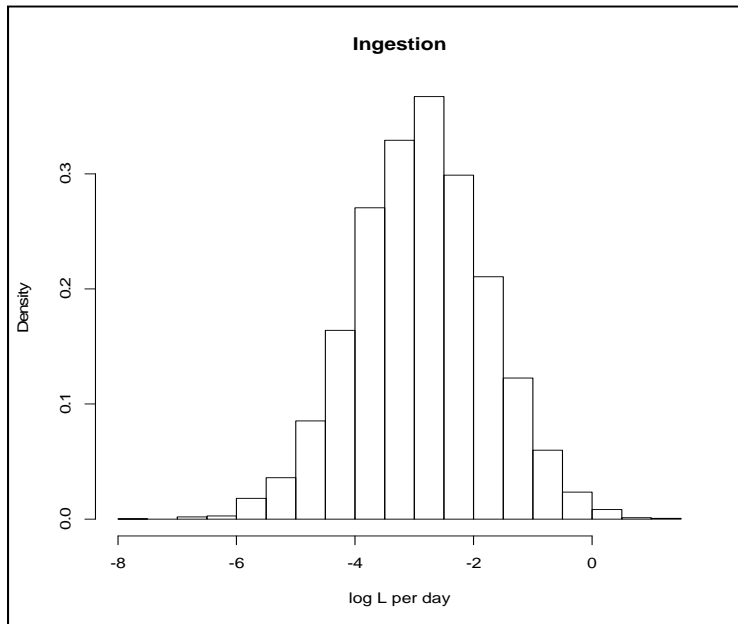

Figure 3.3 Distribution of ingestion volumes for the crop irrigation route of exposure for Scenario I.

Environmental Decay Assumptions

As discussed below, the environmental decay assumptions were pathogen specific. First, for enterovirus, it was assumed that virus concentrations in the environment decayed exponentially with time after application to crops (i.e., decay factor = e^{-kt}) based on findings from Petterson et al. (2001, 2002) and the approach of Hamilton et al. (2006). Based on Petterson's study, the decay constant k was assumed to be normal distributed with a mean of 1.07 and standard deviation of 0.07 (zero-truncated). This k is conservative due to Petterson's use of *B. fragilis* phage, a relatively hardy organism. Based on standard agricultural practices employed in California (February 21, 2012, Panel Meeting; see Appendix 1-3), 7 days of environmental decay was assumed (i.e., mean of 3.3-log removal due to environmental decay).

Second, based on assumptions of the relative differences in decay between viruses, bacteria, and protozoa made in the modeling study by Mara et al. (2007), it was assumed that bacteria were slightly more resistant to environmental decay than viruses. Hence, it was assumed that *E. coli* decayed at 3-log removal over the 7 days. And, for the even more resistant organisms, *Giardia* and *Cryptosporidium*, it was assumed a 2-log reduction due to environmental decay over the 7 days. Additionally, for enteroviruses, a sensitivity analyses on the number of days of environmental decay was conducted as discussed below.

Dose-Response Assumptions

Pathogen-specific dose-response relationships were used to estimate the probability of *infection* (for all pathogens) associated with the computed doses. For each of the pathogens investigated, a summary of the functional forms, distributions used to describe the dose-response parameters, and the dose-response parameters (along with corresponding references to support those data) is presented in Table 3.6. For enterovirus, rotavirus dose response was used as a surrogate. The dose-response relations for rotavirus, *Cryptosporidium*, and *Giardia* are relatively straightforward and commonly used in the field of MRA. The relations utilized for *E. coli* O157:H7 is explained in more detail below.

Table 3.6 Summary of Pathogen Dose Response Relations

Pathogen	Dose-response Form and Endpoint	Parameter Distribution	Value(s)	Value(s)	References
Rotavirus	Hypergeometric (Infection)	Point estimates	$\alpha=0.167$	$\beta=0.191$	Teunis and Havelaar, 2000
<i>Cryptosporidium</i> spp.	Exponential (Infection)	Uniform	$r_{\text{lower}} = 0.04$	$r_{\text{upper}} = 0.16$	U.S. EPA, 2006
<i>Giardia</i> spp.	Exponential (Infection)	Point estimate	$r = 0.0199$		Rose et al., 1991; Teunis et al., 1996
<i>E. coli</i> O157:H7	Hypergeometric (Infection)	Point estimates	$\alpha=0.08$	$\beta=1.44$	Teunis et al., 2004

The dose response relation for *E. coli* O157:H7 is based on a reported outbreak that occurred in Japan in 1996 (Teunis et al., 2004). The outbreak occurred in an elementary school, and school lunches were implicated as the source of contamination. An extraordinary amount of information was available for this outbreak because: 1) in Japan, it is common for catering services to store refrigerated samples of prepared meals and, thus, the suspected foods were available for estimating the concentration of bacteria they contained; 2) all of the exposed subjects (pupils and teachers) were examined for the occurrence of symptoms and illness (fecal specimens were taken) and, thus, health authorities were able to record the occurrence of illness and infection; and 3) the average numbers of bacteria consumed could be estimated relatively accurately (Teunis et al., 2004). Based on the available data, different dose response relationships for teachers and pupils were derived using a Bayesian approach. The relation that was derived by Teunis et al. for students was used in this investigation.

We note that, in one recent recreational water QMRA (Bambic et al., 2011), attention was paid towards harmonizing virus units – making consistent the concentration units from water quality testing with the units reported in dose response studies. For instance, that study acknowledged that their water samples were analyzed by quantitative polymerase chain reaction (qPCR) for rotavirus, while the dose-response relationship of Ward et al. (1986) was in terms of doses of “Focus Forming Units” (FFU). These seemingly incompatible units were equated using a ratio of genome:FFU of ~ 2000. The units used in our study are “most probable number” (MPN), which shares greater similarity with FFU and, hence, alleviates the need for harmonization.

Adenovirus was discussed with the Panel, and was ultimately not analyzed for this report due to the discrepancy between the dose-response relationship and the route of exposure considered for this study of agricultural reuse. The existing dose-response data and relationship (Couch et al., 1966; Crabtree et al., 1997) apply to inhalation; therefore, they may not be applicable to the exposure routes considered (please refer to Section 3.2 for a more detailed discussion of adenovirus).

3.5 Quantitative Microbial Risk Assessment Results and Conclusions

Median annualized risk¹² results for the three application scenarios are shown in Tables 3.7 to 3.9. These scenarios incorporate conservative exposure assumptions – specifically, every exposure event, which is assumed to be daily, is to crops that have been irrigated with reclaimed water.

Because the risk estimates presented here have a right skewed distribution (i.e., longer tail to the right of the histogram), the median is a better indicator of the central tendency of the annualized risk distribution and the estimate of annualized risk than the mean. Thus, for the purpose of this QMRA and addressing the Panel’s primary charge relative to evaluating whether recycled water produced in conformance with California’s Water Recycling Criteria are sufficiently protective of public health for agricultural food crop irrigation, the Panel selected the median risk estimate.

¹² See Appendix 3-2 for “per event” risks for Scenario I, which are approximately two orders less than annualized estimates.

In summary, all median annualized risks of infection, based on the representative microbial concentrations and daily exposure scenarios described above, are at the 1 per 10,000 level or lower of infection.¹³ For example, the estimated median annualized risk of infection for enterovirus for Scenario I (see Table 3.7) is on the order of 7 per 10,000,000 (or 0.7 per 1,000,000). Also, the highest median annualized risk of infection was for *Cryptosporidium*, which was on the order of 1 in 10,000 for Scenario I (see Table 3.7).

Table 3.7 Scenario I. Tertiary Treatment Applied Directly to Crops. Summary of Median Annualized Risk of Infection Assuming All Exposures in the Year Are to Crops Irrigated with Recycled Water (1.3 mL/day)

Statistic	Enterovirus	<i>Giardia</i>	<i>Cryptosporidium</i>	<i>E. coli O157</i>
Median	7.00×10^{-7}	8.54×10^{-5}	2.04×10^{-4}	8.45×10^{-8}

Table 3.8 Scenario II. Secondary Undisinfected Effluent, Not Directly Applied to Edible Portion of Crop. Summary of Median Annualized Risk of Infection Assuming All Exposures in the Year Are to Crops Irrigated with Reclaimed Water (0.1 mL/day)

Statistic	Enterovirus	<i>Giardia</i>	<i>Cryptosporidium</i>	<i>E. coli O157</i>
Median	1.08×10^{-6}	6.49×10^{-5}	9.15×10^{-5}	1.08×10^{-4}

Table 3.9 Scenario III. Secondary Disinfected, Not Directly Applied to Edible Portion of Crop. Summary of Median Annualized Risk of Infection Assuming All Exposures in the Year Are to Crops Irrigated with Reclaimed Water (0.1 mL/day)

Statistic	Enterovirus	<i>Giardia</i>	<i>Cryptosporidium</i>	<i>E. coli O157</i>
Median	2.69×10^{-7}	4.70×10^{-5}	5.78×10^{-5}	1.23×10^{-6}

To provide a better understanding of the distribution of uncertainty on the risk estimates, the results of the static assessment method are presented in Appendix 3-3 through a series of statistical tables that contain the minimum, maximum, mean, and standard deviation (SD) of risk estimate from Monte Carlo simulations. Additionally, the 25th, 50th (median), 75th, 90th, and 95th percentiles of the risk estimate are also shown in Appendix 3-3.¹⁴

¹³ CDPH considers a 1 in 10,000 (i.e., 1×10^{-4}) mean risk of infection to be an acceptable risk from exposure to treated wastewater effluent (CDPH, 2010).

¹⁴ From a risk management perspective, it may be useful to consider the 75th, 90th, and 95th percentile risks estimates if the policy is to be more conservative in protecting against infection. In Hamilton et al. (2006), the risk assessment focus was placed on the 95 percentile in the interest of conservativeness with respect to health protection. In the Tanaka et al. (1998) risk assessment, both the 90th and 95th percentiles were considered, and focus was placed on the 95th percentile based on the EPA's Surface Water Treatment Rule (SWTR) criterion that turbidity in finished water be below the maximum level at least 95 percent of the time. However, in estimating annualized risk, the authors use the term "expectation of annual risks" defined as an average

Sensitivity Analyses

Several sensitivity analyses were explored. Except where noted, all sensitivity analyses were performed for enterovirus with tertiary treatment and direct application to edible crops (see Scenario I).

The first analysis considers that not all exposures over the year are likely to be to crops irrigated with recycled water. As described in Section 2.1, projections suggest that recycled water may be applied to approximately 8 percent of crops. Applying this percentage as the approximate percentage of exposures to recycled water-irrigated crops over the year results in the adjusted annualized risks for Scenario 1, as shown in Table 3.10. These risks are approximately one order of magnitude lower than the risks, assuming exposure to recycled water-irrigated crops every day (see Table 3.7).

Table 3.10 Scenario I. Tertiary Treatment Applied Directly to Crops. Summary of Annualized Risks of Infection Assuming 8 Percent of Exposures in the Year Are to Crops Irrigated with Reclaimed Water

Statistic	Enterovirus	<i>Giardia</i>	<i>Cryptosporidium</i>	<i>E. coli O157</i>
Min	0	9.80×10^{-12}	4.72×10^{-11}	0
0.25	5.16×10^{-9}	6.24×10^{-7}	1.55×10^{-6}	6.43×10^{-10}
Median	5.76×10^{-8}	7.02×10^{-6}	1.68×10^{-5}	6.94×10^{-9}
0.75	6.30×10^{-7}	7.88×10^{-5}	1.75×10^{-4}	7.78×10^{-8}
0.9	5.48×10^{-6}	7.03×10^{-4}	1.41×10^{-3}	6.63×10^{-7}
0.95	2.00×10^{-5}	2.66×10^{-3}	5.10×10^{-3}	2.43×10^{-6}
Max	2.29×10^{-1}	1.00	1.00	8.91×10^{-4}
Mean	4.76×10^{-5}	2.03×10^{-3}	3.12×10^{-3}	1.66×10^{-6}
SD	2.39×10^{-3}	2.57×10^{-2}	3.07×10^{-2}	1.96×10^{-5}

value of the risks for many exposures. Further, the authors state it may be argued that this may be overly stringent, citing Regli et al. (1988), who report risks that are generally higher from swimming in natural waters, and the work of Cabelli et al. (1979, 1982) that suggests even one order of magnitude larger risks are still acceptable to voluntary swimmers. As another example, the existing Ambient Water Quality Criteria for bacteria in recreational waters are set to limit the rate of highly credible gastrointestinal illness in swimmers, based on a geometric mean of indicator organisms, to no more than eight per 1,000 people per year (or 0.008 pppy) in freshwater and 19 per 1,000 in marine waters (or 0.019 pppy) (U.S. EPA, 1986)

Ultimately, in selecting the median versus one of the upper percentile risk estimates for managing risk, there is a need to consider many factors, including the conservativeness of the model assumptions, comparable risks, what level of risk is deemed acceptable, available technology for control, cost-efficacy of control, and perceived (as well as observed) health impacts associated with the risk of infection.

A more comprehensive analysis of the numbers of days of exposure is presented in Figure 3.4, which illustrates the shift in the distribution of modeled annualized risks for different exposure assumptions: exposure every day of the year, exposure every other day, 70 days out of the year (consistent with assumptions made by Kahn, 2008), and 8 percent of exposure in the year. The risk results are relatively insensitive to this exposure factor, varying by 1.5 orders of magnitude.

Second, a sensitivity analysis was performed on the number of days of environmental decay and an alternative decay rate from Asano et al. (1992) of $k=0.69$ was considered. The annualized risk results for different assumptions are shown in Table 3.11. The risk results are highly sensitive to environmental decay assumptions, varying by four to six orders of magnitude, depending on the assumption.

Third, a sensitivity analysis was performed on treatment efficacy. In this analysis, a single point estimate of log removal was specified to generate annualized risk. The distributions of annualized risk for different log-removal efficacy assumptions are shown in Figure 3.5. Risks vary across a wide range because a wide range of treatment efficacies were considered. Generally, each additional log removal results in approximately one order of magnitude lower annual risk.

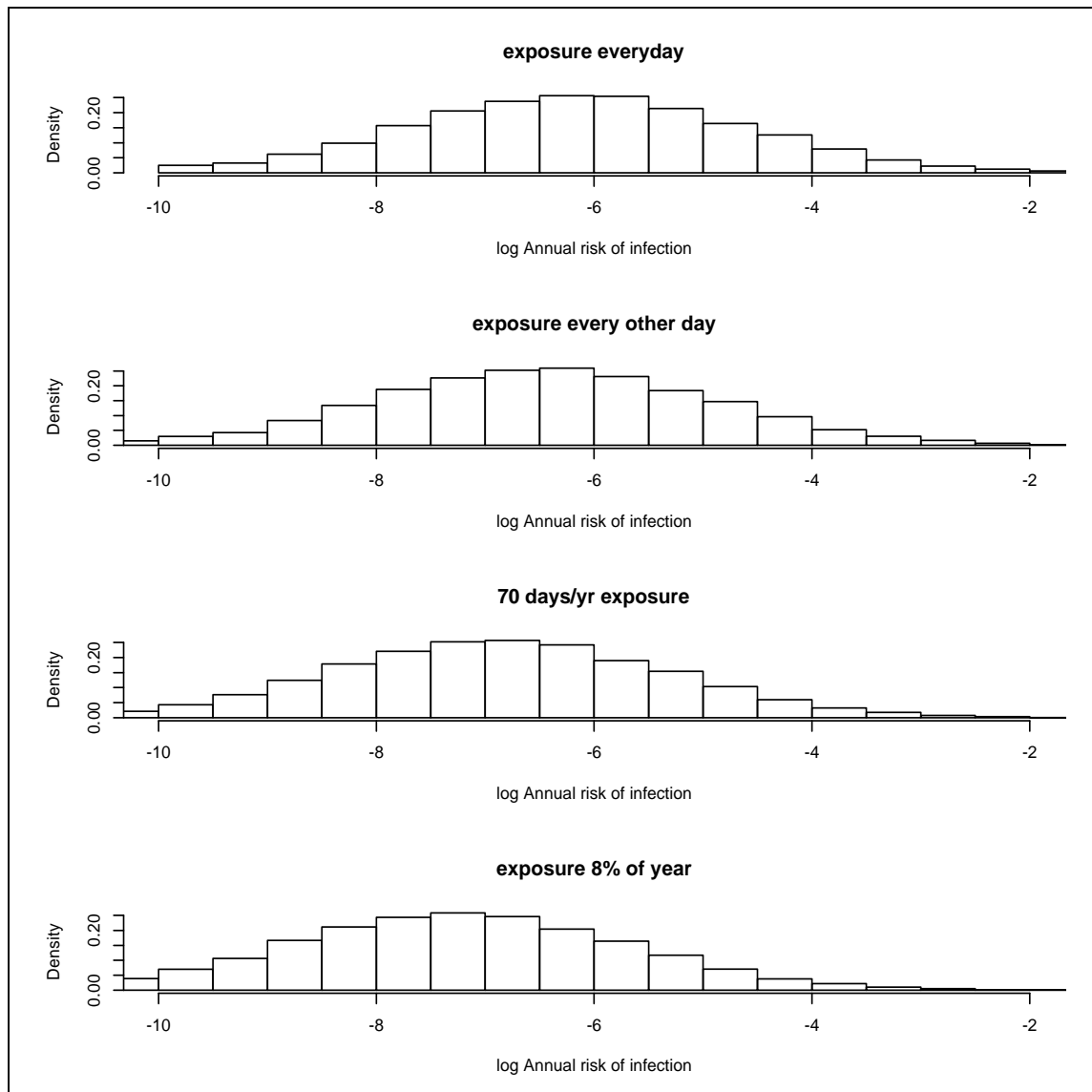

Figure 3.4 Distribution of annualized risk for different exposure assumptions.

Table 3.11 Sensitivity Analysis for Enterovirus Annualized Risk Estimates of Environmental Decay Rates (Log Reduction over Time)

K Rate	Statistic	1 Day	7 Days	14 Days
Asano et al. (1992)	Median	6.46×10^{-4}	1.03×10^{-5}	8.21×10^{-8}
Asano et al. (1992)	Mean	3.71×10^{-2}	2.51×10^{-3}	4.32×10^{-5}
Asano et al. (1992)	SD	1.38×10^{-1}	3.04×10^{-2}	1.40×10^{-3}
Petterson et al. (2001)	Median	4.35×10^{-4}	7.00×10^{-7}	4.65×10^{-10}
Petterson et al. (2001)	Mean	2.99×10^{-2}	3.68×10^{-4}	7.35×10^{-7}
Petterson et al. (2001)	SD	1.23×10^{-1}	1.17×10^{-2}	4.91×10^{-5}

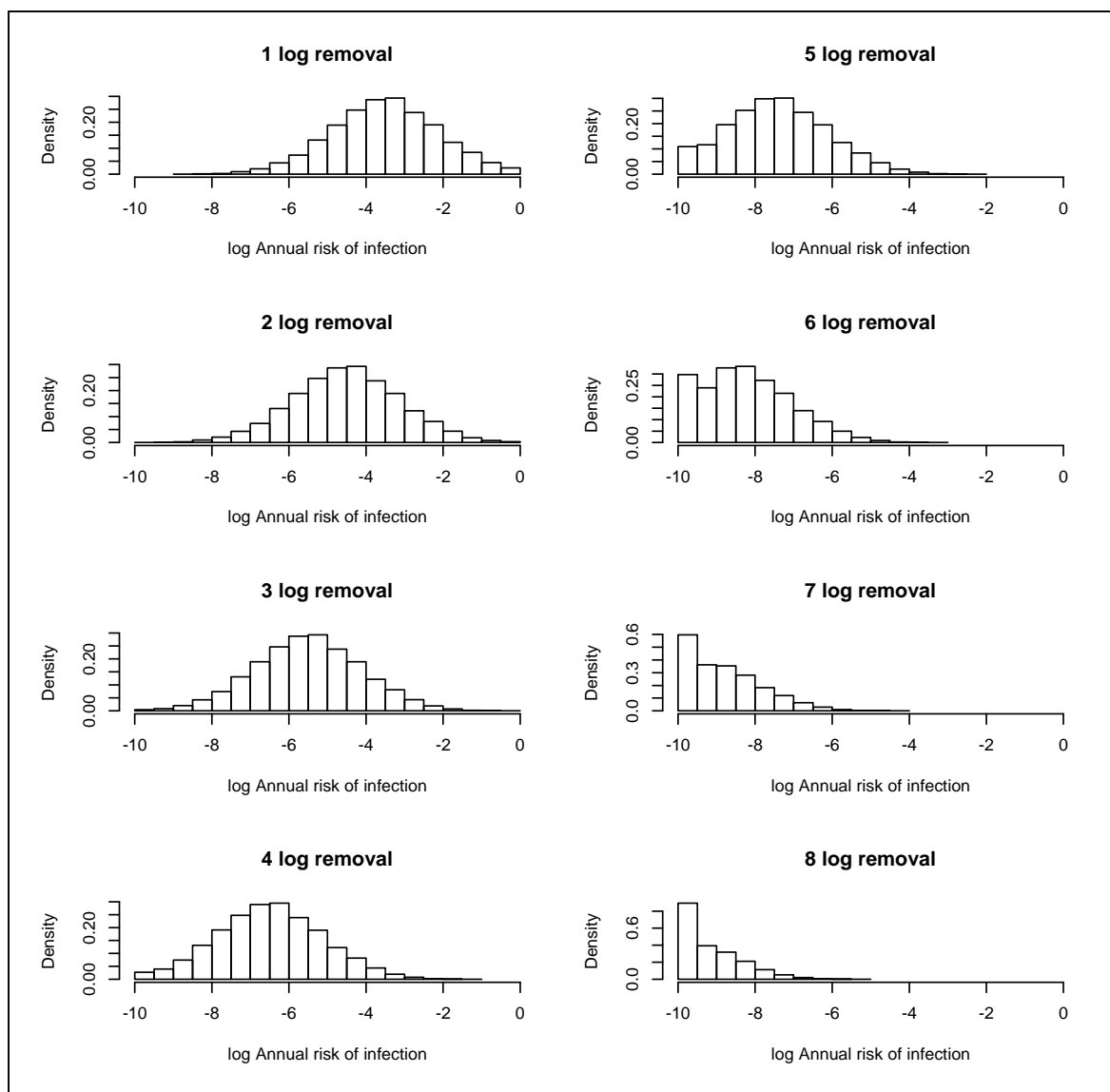

Figure 3.5. Sensitivity analysis of treatment efficacy.

Finally, for Scenarios II and III, which consider applications of water reuse to non-edible portions of crops, an alternative exposure assumption that was one order of magnitude lower was considered (ingestion volume of 0.01 mL/day). This resulted in the annualized risks presented in Tables 3.12 and 3.13. These are approximately one order of magnitude lower risks than their higher exposure counterparts (see Tables 4.7 and 4.8 in Section 4).

In summary, the sensitivity analyses suggest linear sensitivities to treatment efficacy (one order of magnitude risk per 1-log removal), and especially large sensitivities with respect to environmental decay assumptions (four to six orders of magnitude in risk). The risk results are relatively insensitive to days of exposure (1.5-orders of magnitude). And, the Scenario II and III results are somewhat insensitive to exposure volumes assumed (one order of magnitude of risk for one order of magnitude lower volume).

Table 3.12 Scenario II. Secondary Undisinfected, Not Directly Applied to Edible Portion of Crop. Summary of Annualized Risks of Infection Assuming All Exposures in the Year Are to Crops Irrigated with Reclaimed Water (0.01 mL/day)

Statistic	Enterovirus	<i>Giardia</i>	<i>Cryptosporidium</i>	<i>E. coli</i> O157
Min	0.00	1.20×10^{-10}	9.67×10^{-10}	1.60×10^{-11}
0.25	2.66×10^{-8}	1.02×10^{-6}	1.84×10^{-6}	2.21×10^{-6}
Median	1.08×10^{-7}	6.49×10^{-6}	9.15×10^{-6}	1.08×10^{-5}
0.75	4.19×10^{-7}	3.86×10^{-5}	4.53×10^{-5}	5.05×10^{-5}
0.9	1.37×10^{-6}	1.87×10^{-4}	1.80×10^{-4}	2.08×10^{-4}
0.95	3.00×10^{-6}	5.06×10^{-4}	4.21×10^{-4}	5.04×10^{-4}
Max	1.36×10^{-4}	1.25×10^{-4}	3.85×10^{-2}	9.69×10^{-2}
Mean	7.58×10^{-7}	1.85×10^{-4}	1.24×10^{-4}	1.44×10^{-4}
SD	3.40×10^{-6}	1.83×10^{-3}	7.88×10^{-4}	1.19×10^{-3}

Table 3.13 Scenario III. Secondary Disinfected, Not Directly Applied to Edible Portion of Crop. Summary of Annualized Risks of Infection Assuming All Exposures in the Year Are to Crops Irrigated with Reclaimed Water (0.01 mL/day)

Statistic	Enterovirus	<i>Giardia</i>	<i>Cryptosporidium</i>	<i>E. coli</i> O157
Min	0	1.09×10^{-10}	3.87×10^{-10}	0
0.25	5.11×10^{-9}	7.70×10^{-7}	1.09×10^{-6}	7.53×10^{-9}
Median	2.69×10^{-8}	4.70×10^{-6}	5.78×10^{-6}	1.23×10^{-7}
0.75	1.33×10^{-7}	2.68×10^{-5}	3.10×10^{-5}	1.74×10^{-6}
0.9	5.52×10^{-7}	1.25×10^{-4}	1.33×10^{-4}	1.99×10^{-5}
0.95	1.36×10^{-6}	3.30×10^{-4}	3.26×10^{-4}	9.33×10^{-5}
Max	1.98×10^{-4}	7.02×10^{-2}	3.52×10^{-2}	6.05×10^{-1}
Mean	4.18×10^{-7}	1.15×10^{-4}	1.02×10^{-4}	1.63×10^{-4}
SD	3.18×10^{-6}	1.07×10^{-3}	7.15×10^{-4}	6.22×10^{-3}

Relationships between Panel findings and other previous risk assessment modeling studies

Previous studies have considered the degree to which wastewater reuse treatment processes meet acceptable use criteria. Using numerical simulation, Tanaka et al. (1998) evaluated four exposure scenarios, including one for food crop irrigation (using enteric virus data collected from unchlorinated secondary effluent grab samples from wastewater plants in Southern California) with the goal of determining whether the 1989 EPA's Surface Water Treatment Rule (SWTR) for acceptable risk (less than one infection per 10,000 population per year) is met.

The approach of Tanaka et al. (1998) is similar to that described in this Panel report, which is based on assessing the distribution of concentrations before and after tertiary treatment, factoring in ingested dose based on exposure assumptions, and using a dose-response relationship to estimate risk. They assume virus reductions according to the Pomona Virus Study, in which seeded poliovirus was recovered from tertiary treatment processes (CSDLAC, 1977; Dryden et al., 1979; Miele and Selna, 1977). Their assumptions for crop irrigation exposure are that consumers are exposed every day to 10 mL of recycled water through the ingestion of spray-irrigated food. Also, it is assumed that irrigation is stopped 2 weeks before harvest and shipment, and that virus reduction occurs from sunlight exposure over this period, which follows an exponential decay e^{-kt} , where $k=0.69$ and $t=14$ days as assumed by Asano et al. (1992). Accordingly, over 14 days, the proportion of remaining virus is 0.00006. Finally, a beta-Poisson rotavirus dose-response (Rose and Gerba, 1991) was used.

Working backwards, Tanaka et al. (1998) found that between 0 and 2.1 log removal of enteric virus by tertiary treatment is necessary to reliably reach the SWTR 95 percent of the time. Also, they found that, based on the Pomona Virus Study log-removal efficiencies (which range from 3.9 to 5.2 logs), tertiary treatment should be 100-percent reliable at meeting the SWTR at the plants where virus was measured. In addition, their expected annualized risks¹⁵ ranged from approximately:

- 10^{-10} to 10^{-8} for full treatment (5.2-log removal).
- 10^{-7} to 10^{-9} for chlorination of secondary effluent (3.9-log removal).
- 10^{-5} to 10^{-3} for unchlorinated secondary effluent (0 log removal).

Using their assumptions, the QMRA model used in this investigation is able to reproduce the Tanaka et al. findings to the same order of magnitude. The assumptions used by the Panel are somewhat more conservative in some respects (e.g., only 7 days of environmental decay, and less treatment efficacy than 5.2-log removal for full treatment) and, in many ways, allow more uncertainty and variability than Tanaka et al. (1998) (e.g., distributions on treatment efficacy and ingestion rates). The Panel's findings of infection risk of 10^{-7} are more conservative than Tanaka's 10^{-10} to 10^{-8} for full treatment.

The study by Hamilton et al. (2006) provides another comparison. This study reassessed Tanaka et al. (1998) wastewater plant data from Southern California, but used an updated exposure relationship (the same as our approach) and allowed for three different amounts of environmental decay (1, 7, and 14 days). Their annualized infection risk for lettuce consumption with a 7-day decay period for the application of non-disinfected secondary recycled water ranged from 10^{-4} to 10^{-3} . Their estimates, as expected, are considerably higher than those developed as part of the above analysis for Scenario III of lettuce consumption based on full disinfected tertiary treatment.

¹⁵ Results shown are from Table 7, Scenario II of Tanaka et al. (1998). The term "expectation of annual risks" is defined by Tanaka et al. as an average value of the risks for many exposures.

3.6 Acceptable or Tolerable Risk

One of the most important issues that should be addressed is that of defining “acceptable”¹⁶ or “tolerable risk” as it relates to water recycling for nonpotable uses. Evaluating the adequacy of a particular treatment train requires a benchmark level (or set of criteria) that can be used for comparison. Selecting a benchmark level of risk (or *de minimis* level) is a complicated process that involves the evaluation of technical, political, and social factors, which is outside of the Panel’s charge. However, to provide input and guidance to CDPH on this subject, the Panel utilized a “weight-of-evidence” approach that looked at four key factors:

- Current regulatory examples of acceptable and/or tolerable risk.
- CDPH historical background information and assumptions regarding public health risk associated with developing recycled water standards.
- Past and current QMRAs for recycled water.
- Comparison of estimated public health risk to diarrheal disease incidence rates in the United States.

There are a number of examples of how “acceptable “risk has been defined that are described below.

- For the SWTR (which was developed as one component of the Safe Drinking Water Act), a risk of one infection per 10,000 people per year (or 0.0001 pppy) was taken as a reasonable and acceptable health goal (Macler and Regli, 1993). As drinking water regulations evolved, so did the process that is used to evaluate the adequacy of treatment. One of the more recent drinking water regulations, the Long Term 2 Enhanced Surface Water Treatment Rule (LT2 Rule), requires public water systems to augment their water treatment processes if the mean source water *Cryptosporidium* levels correspond to an estimated annual infection level of two per 1,000 persons or greater (U.S. EPA, 2006). The process that was used to arrive at the levels described in the Final LT2 Rule involved review by a scientific advisory committee, public comment, and numerous technical considerations, including monitoring feasibility.
- As another example, the existing Ambient Water Quality Criteria for bacteria in recreational waters are set to limit the rate of highly credible gastrointestinal illness¹⁷ in swimmers to no more than eight per 1,000 (or 0.008 pppy) in freshwater and 19 per 1,000 in marine waters (or 0.019 pppy), based on Geometric Mean values for indicator organisms (U.S. EPA, 1986).¹⁸

¹⁶ Acceptable risk can be defined as the level of risk that is protective of public health for a population considering cost, feasibility, and other considerations. WHO recommends “tolerable” risk that can be borne by a particular community and has placed an emphasis on incorporating the concept of adjusting life years based on disability (i.e., considering severity and duration of a disease/infection allows shifting from parasites to viruses as the waterborne pathogen of concern).

¹⁷ The following definition is currently used by the EPA for defining Highly Credible Gastrointestinal Illness (HCGI): “Any one of the following unmistakable or combinations of symptoms (within 8 to 10 days of swimming): 1) vomiting, 2) diarrhea with fever or disabling condition (remained home, remained in bed, or sought medical advice because of symptoms), and 3) stomach ache or nausea accompanied by a fever.”

¹⁸ EPA estimated acceptable risk values based on the observed relationships between the fecal indicator bacteria (FIB) concentrations and gastrointestinal illness (U.S. EPA, 1986).

- WHO (2004) defined the “tolerable” risk of disease for fully treated drinking water to be one per 1,000 (or 0.1 percent of disease in the community per year). Some public health experts have indicated that a more “acceptable” level of risk should be based on infection and be on the order of 1 per 100 (or 1 percent of the community infected per year) (Mara et al, 2007).

A brief review of the historical CDPH record (California Department of Health Services, 1991; 1987) for the development of the CDPH water reuse regulations and the CDPH guidance on wastewater disinfection indicates the following:

- The acceptable incidence of symptoms for diarrhea, fever, rash, mild infectious hepatitis, and vomiting for persons exposed to recycled water is four per 100,000 (this could be as low as one per 100,000, depending on the symptom or disease), and the assumed probability of infection associated with the above symptoms is on the order of one per 1,000 (based on a ratio of disease to infection of 1 to 100 [Pipes, 1978]).
- The assumptions used to estimate an acceptable risk of infection for swimming in receiving waters where secondary treated disinfected wastewater is discharged (fecal coliform <23 MPN/100 mL) and 100 mL of water is consumed was calculated by CDPH staff to be on the order of two per 1,000 for *Giardia lamblia* and eight per 100,000 for enteroviruses (Polio I). The CDPH report notes that the estimates reduced the 1986 U.S. EPA acceptable risk of illness for recreation by roughly 50 percent.

Currently, there are no Federal or State laws and/or regulatory standards defining “acceptable” risk for nonpotable water recycling. While numerical standards are useful, they can never be applicable and/or protective for all exposures, all pathogens, and all individuals. Further, from a public health perspective, they may or may not be necessary depending on how regulations are developed, implemented, and enforced. While this is the case for the California Water Recycling Criteria, CDPH appropriately developed treatment-based standards that include the need for multiple barriers, a high level of plant reliability, and process redundancy.

CDPH implementation of the Water Recycling Criteria is based on a goal that the treatment-based standards provide sufficient overall plant reliability to achieve the U.S. EPA SWTR (i.e., potable drinking water) acceptable risk goal of one infection per 10,000 people per year for enteric viruses (or *de minimis* level applied as a mean¹⁹). Achieving the SWTR acceptable risk goal was evaluated from a plant reliability perspective at four California water recycling operations (i.e., Orange County Sanitation District separately for activated sludge and trickling filter processes, Pomona, and the Monterey Regional Water Pollution Control Agency) for a number of exposure routes, including food crop irrigation (i.e., based on the assumption that crops are consumed every day, 10 mL of exposure volume per day, no irrigation for 2 weeks before harvest, and sunlight inactivation) for enteric viruses. Tanaka et al. (1998) concluded that the estimated annual risk of infection for full treatment (i.e., secondary plus filtration per the

¹⁹ CDPH considers a 1 in 10,000 (i.e., 1×10^{-4}) mean risk of infection to be an acceptable risk from exposure to treated wastewater effluent (CDPH, 2010).

recycling criteria) or contact filtration (i.e., direct filtration) and high chlorine dose (i.e., 5.2-log removal of seeded polio virus) and for secondary treatment and high chlorine dose (i.e., 3.9-log removal) are less than one per 10,000, even at a 95-percent confidence level (CL). In addition, WateReuse Research Foundation (WRRF) (Olivieri et al., 2007) recently conducted an MRA for several nonpotable reuses (i.e., full body contact-unrestricted recreation, landscape irrigation–restricted and unrestricted, and food crop irrigation–edible and non-edible) and concluded that the estimated daily risk of infection for exposure through food crop irrigation was approximately:

- A median of 3.1 to 3.9 per 100,000 (disinfected secondary) to 1 per 100,000 to 4.5 per 1,000,000 (disinfected tertiary) for parasites (i.e., *Giardia* and *Cryptosporidium* spp.).
- A median of 1.7 per 100,000 (disinfected secondary) to 3.9 per 1,000,000 for enteric viruses.

Although Tanaka et al. (1998) and WRRF (Olivieri et al., 2007) employed slightly different assumptions for exposure, dose-response, field decay period, and treatment effectiveness, a comparison of the overall results for the risk of infection from enteric viruses for water recycling on edible food crops are within an order of magnitude.

Finally, the results of the QMRA conducted as part of this Panel’s investigation indicate that annualized median risks of infection for full tertiary treatment range from 10^{-8} to 10^{-4} (for the selected pathogens), and accounting for the likelihood that only 8 percent of crops will be irrigated with recycled water, the annualized median risks are an order of magnitude lower, 10^{-9} to 10^{-5} . Furthermore, it is important to note that the estimated median risks are for infection rather than disease (not all infections result in clinical disease).

To bring this work into overall perspective, the estimated diarrheal disease incidence for all ages in developed countries is on the order of 0.2 per person per year (Mathers et al., 2002) to 0.72 per person per year (Imhoff et al., 2004).^{20,21} Comparison of the 0.2 per person per year (pppy) disease incidence (assuming that the ratio of infection/disease is 1, which is highly conservative and unlikely²²) against the “tolerable and/or acceptable” levels currently used for drinking water and surface water regulations indicates that those levels are several (at least 2) orders of magnitude lower than the diarrheal disease incidence in developed countries and, most likely, would not measurably raise the incidence level. This comparison does not assume that the diarrheal disease incidence rate is considered acceptable by the Panel. However, the above weight-of-evidence allows the Panel to address two key questions:

²⁰ Re-analysis of the FoodNet population survey data in the United States for the period 2000-2003 resulted in an adjusted rate of 0.65 pppy (Roy et al., 2006).

²¹ Roy et al. (2006) further indicate that the FoodNet studies are the most generalizable to the United States population, probably provide the best data currently available for the United States, and could have resulted in an over-reporting and, thus, overestimate of the rate due to the retrospective study design.

²² Pipes (1978) estimated that one of every 100 infections may result in disease.

1. Should CDPH develop an “acceptable” or “tolerable” risk metric for Water Recycling Criteria reuse applications? Based on this Panel’s review and analysis, the Panel does not believe at this time that developing an acceptable or tolerable risk metric is warranted.
2. Is there any evidence that the current treatment-based Water Recycling Criteria increase the risk to public health through irrigation of food crops with recycled water? The Panel’s review of the available weight-of-evidence, including past (Tanaka et al. [1998] and Olivieri et al. [2007]) and current QMRA results (Section 3.0), confirms that current agricultural practices consistent with the Water Recycling Criteria do not increase public health risk and that modifying the standards to make them more restrictive will not improve public health.

References

- Anderson, R. M., and May, R. (1991). *Infectious Diseases of Humans: Dynamics and Control*, New York: Oxford University Press.
- Asano, T., Leong, L.Y.C., Rigby, M.G., and Sakaji, R.H., (1992) Evaluation of the California Wastewater Reclamation Criteria Using Enteric Virus Monitoring Data. *Water Sci. Technol.*, 26, 1513.
- Bambic, D., McBride, G., Miller, W., Stott, R., Wuertz, S. (2011) Quantification of Pathogens and Sources of Microbial Indicators for QMRA in Recreational Waters, WERF, PATH2R08.
- Cabelli, V. J. (1983). "Public health and water quality significance of viral diseases transmitted by drinking water and recreational water". In: *Water Virology*, W.O. Grabow (ed.); *Water Sci. Tech.* 15(5): 1-15.
- Cabelli, V.J., Dufour, A.P., Levin, M.A., McCabe, L.J., and Harberman, P.W. (1979) Relationship of Microbial Indicators to Health Effects at Marine Bathing Beaches. *Am. J. Public Health*, 69, 690.
- Cabelli, V.J., Dufour, A.P., McCabe, L.J., and Levin, M.A. (1982) Swimming-Associated Gastroenteritis and Water Quality. *Am. J. Epidemiol.*, 115, 606.
- California Department of Health Services (1991) Excerpts from Environmental management Branch, Draft statement of Reasons Relating to Risk of Exposure to Reclaimed Water Used other than for groundwater Recharge, December 10, 1991.
- California Department of Public Health, Executive Summary (1987) Wastewater Disinfection for Health protection, February, 1987.
- Colford, J. M., Eisenberg, D. M., Eisenberg, J. N., Scott, J., and Soller, J. A. (2003). "A Dynamic Model to Assess Microbial Health Risks Associated with Beneficial Uses of Biosolids – Phase 1", *Water Environment Research Foundation Report, Project 98-REM-1*.
- Cooper, R. C., Olivieri, A. W., Danielson, R. E., Badger, P. G., Spear, R. C., and Selvin, S. (1986). "Evaluation of military field-water quality, volume 5: infectious organisms of military concern associated with consumption: assessment of health risks and recommendations for establishing related standards." UCRL-21008, Lawrence Livermore

Laboratory.

- Cooper, R. C. (1991). "Public health concerns in wastewater reuse" *Water Science and Technology*, 4(9), 55-65.
- Couch, R.B., Cate, T.R., Dougl, R.G., Gerone, P.J. and Knight, V. (1966) Effect of route of inoculation on experimental respiratory viral disease in volunteers and evidence for airborne transmission. *Bacteriol. Rev.*, 30, 517-529.
- County Sanitation Districts of Los Angeles County (CSDLAC) (1977). *Pomona Virus Study, Final Report*, Prepared for California State Water Resources Control Board, Sacramento, Calif., and U.S. EPA, Washington, D.C.
- Crabtree, K. D., Gerba, C. P., Rose, J. B., and Haas, C. N. (1997). "Waterborne adenovirus: A risk assessment" *Water Science and Technology*, 35(11-12), 1-6.
- Dryden, F.D., Chen, C.L. and Selina, M.W. (1979). Virus Removal in Advanced Wastewater Treatment Systems. *J Water Pollution Control Fed.*, 51, 2098.
- Eisenberg, J. N., Olivieri, A. W., Thompson, K., Seto, E. Y. W., and Konnan, J. I. (1996a). An Approach to Microbial Risk Assessment. AWWA and WEF, Water Reuse 96.
- Eisenberg, J. N., Seto, E. Y. W., Olivieri, A., and Spear, R. C. (1996b). "Quantifying water pathogen risk in an epidemiological framework" *Risk Analysis*, 16(4), 549-563.
- Eisenberg, J. N. S., Seto, E. Y. W., Colford, J. M., Jr., Olivieri, A., and Spear, R. C. (1998). An analysis of the Milwaukee cryptosporidiosis outbreak based on a dynamic model of the infection process. *Epidemiology*, 9(3), 255-263.
- Fankhauser, R. L., Noel, J. S., Monroe, S. S., Ando, T., and Glass, R. I. (1998). "Molecular epidemiology of "Norwalk -like viruses" in outbreaks of gastroenteritis in the United States" *J. Infect. Dis.*, 178(6), 1571-1578.
- Farber, J. M., Ross, W. H., and Harwig, J. (1996). "Health risk assessment of *Listeria monocytogenes* in Canada" *International Journal of Food Microbiology*, 30(1-2), 145-156.
- Foy, H.M. (1997) Adenovirus. In: Evans AS, Kaslow, R.A. (eds.) *Viral Infections of Humans: Epidemiology and Control*, 4th Ed., Plenum Publishing Corp., New York, N.Y., 119-138.
- Garcia-Aljaro, C., Bonjoch, X., and Blanch, A.R., Combined use of an immunomagnetic separation method and immunoblotting for the enumeration and isolation of *Escherichia coli* O157 in wastewaters. *J Appl Microbiol* 2005, 98, (3), 589-97.
- Gerba C.P., Gramos, D.M., and Nwachuku, N. (2002) Comparative Inactivation of Enteroviruses and Adenovirus 2 by UV light., *Appl. Environ. Microbiol.*, 68:5167-5169.
- Gupta, M. and C. N. Haas (2004). "The Milwaukee Cryptosporidium Outbreak: Assessment of Incubation Time and Daily Attack Rate." *Journal of Water and Health* 2(2): 59-69.
- Haas, C.N. (1983). "Effect of Effluent Disinfection on Risks of Viral Disease Transmission via Recreational Exposure." *Journal of the Water Pollution Control Federation*. 55, 1111-1116.
- Haas, C.N., Rose, J.B., and Gerba, C.P. (1999). *Quantitative Microbial Risk Assessment*, John W. Wiley, Inc. (NY) (translated into Japanese).

- Hamilton, A. J., F. Stagnitti et al. (2006). "Quantitative microbial risk assessment models for consumption of raw vegetables irrigated with reclaimed water." Applied and Environmental Microbiology 72(5): 3284-3290.
- Heijnen, L. and Medema, G., Quantitative detection of E. coli, E. coli O157 and other shiga toxin producing E. coli in water samples using a culture method combined with real-time PCR. *J Water Health* 2006, 4, (4), 487-98.
- Hethcote, H. (1976). Qualitative analyses of communicable disease models. *Math Biosci.*, 28, 335-356.
- Imhoff, B., Morse, D., Shiferaw, B., Hawkins, M., Vugia, D., Lance-Parker, S., Hadler, J., medus, C., Kennedy, M., Moore, M.R., Van Gilder, T. & the Emerging Infectious program FoodNet Working Group., Burden of Self-reported acute diarrheal illness in FoodNet surveillance areas, 1998-1999. *Clin. Infect. Dis.* 2004, 38, Suppl 3:s219 – S226.
- Khan, S. (2008). *Quantitative Risk Assessment for Recycled Water*, UNSW Water Research Centre, University of New South Wales, NSW, Australia, WRC08/23.
- Levine, W.C., and Stephenson, W.T. (1990) "Waterborne Disease Outbreaks, 1986-1988" *Morb. Mort. Wkly. Rpt.* Vol. 39/No. SS-1.
- Macler, B.A. & Regli, S., (1993) Use of Microbial Risk Assessment in Setting United-States Drinking-Water Standards. *International Journal of Food Microbiology* 1993, 18, (4), 245-56.
- Mara, D.D., Sleigh, P.A., Blumenthal, U.J., and Carr, R.M. (2007). Health Risks in Wastewater Irrigation: Comparing Estimates from Quantitative Microbial Risk Analyses and Epidemiological Studies, *Journal of Water and Health*, 05.1, 39-50.
- Mathers, C.D., Stein, C., fat, D.M., Rao, C., Inoue, M., Tomijima, N., Bernard, C., Lopez, A.D., and Murray, C.J.L. (2002) *Global Burden of Disease 2000: version 2 Methods and Results*. World Health organization, October, 2000.
- Mead, P. S., Slutsker, L., Dietz, V., McCaig, L. F., Bresee, J. S., Shapiro, C., Griffin, P. M., and Tauxe, R. V. (1999). "Food related illness and death in the United States" *Emerg. Infect. Dis.*, 5(5), 607-625.
- Mena, K.D. and Gerba, C.P. (2008) *Waterborne Adenovirus*, D.M. (ed.) *Review of Environmental Contamination and Toxicology*, Vol. 198, 133-167.
- Miele, R.P. and M.W. Selina (1979). Virus Sampling in Wastewater Field Experiences. *J. Environ. Eng. Div.*, 103, EE4, 693.
- Muniesa, M., Jofre, J., Garcia-Aljaro, C. & Blanch, A.R., Occurrence of Escherichia coli O157:H7 and other enterohemorrhagic Escherichia coli in the environment. *Environ Sci Technol.* 2006, 40, (23), 7141-9.
- National Research Council. (1983). "Risk Assessment in the Federal Government: Managing the Process," National Academy Press, Washington, D.C.
- Olivieri, A.W., R.C. Cooper, J. Konnan, J. Eisenberg, and E. Seto (1995a). Mamala Bay Study Infectious Disease Public Health Risk Assessment. Technical Report Prepared by EOA, Inc. for the Mamala Bay Study Commission.

- Olivieri, A.W., J. Eisenberg, J. Konnan, and E. Seto (1995b). Microbial Risk Assessment for Reclaimed Water. Technical Report Prepared by EOA, Inc. and UC Berkeley for the Irvine Ranch Water District and the National Water Resource Association.
- Olivieri, A. W., Eisenberg, D. M., Soller, J., Eisenberg, J. N. E., Cooper, R. C., Tchobanoglous, G., Trussell, R. R., and Gagliardo, P. (1999). "Estimation of pathogen removal in an advanced water treatment facility using Monte Carlo simulation" *Water Sci. Technol.*, 40(4-5)(4-5), 223-233.
- Olivieri, A.W., R.C. Cooper, R.C. Spear, S. Selvin, R.E. Danielson, D.E. Block, and P.G. Badger, (1986). Risk assessment of waterborne infectious agents. Envirosoft 86, Computational Mechanics Publications.
- Olivieri, A.W., E. Seto, and J. Soller (2007). *Application of Microbial Risk Assessment Techniques to Estimate Risk Due to Exposure to Reclaimed Waters (WRF-04-001)*. WateReuse Research Foundation, Alexandria, Virginia.
- Ott, W.R., (1995) "Environmental Statistics and Data Analysis". *Lewis Publishers, Boca Raton, FL*. 1995.
- Palmateer, G. A., Dutka, B. J., Janzen, E. M., Meissner, S. M., and Sakellaris, M. G. (1991). "Coliphage and bacteriophage as indicators of recreational water quality" *Water Res.*, 25(3), 355-357.
- Petterson, S. R., N. J. Ashbolt, et al. (2001). "Microbial risks from wastewater irrigation of salad crops: A screening-level risk assessment." *Water Environment Research*: 667-672.
- Petterson, S. R., N. J. Ashbolt, et al. (2002). "Of: Microbial risks from wastewater irrigation of salad crops: A screening-level risk assessment." *Water Environment Research*: 411.
- Pipes, W.O. (1978). *Water Quality and Health Significance of Bacterial Indicators of Pollution*, Drexel University, Philadelphia, Pennsylvania.
- Regli, S., Amirtharajah, A., Borup, B., Hibler, C., Hoff, J., and Tobin, R. (1988) Panel Discussion on the Implication of Regulatory Changes for Water Treatment in the United States. In *Advances in Giardia Research*. P.M. Walls et al. (Eds.), Univ. Calgary Press, Alb., Can., 275.
- Regli, S; Rose, JB; Haas, CN; Gerba, CP. (1991). Modeling the risk from giardia and viruses in drinking-water. *Journal American Water Works Association* 83 (11): 76-84.
- Rose, J.B., and Gerba, C.P. (1991). Assessing potential health risks from viruses and parasites in reclaimed water in Arizona and Florida, USA. *Water Science and Technology*, 23(10/2): 2091-98.
- Rose, JB; Haas, CN; Regli, S. (1991). Risk assessment and control of waterborne giardiasis. *American Journal of Public Health* 81 (6): 709-713.
- Rose, J.B., Nowlin, H., Farrah, S.R., Harwood, V., Levine, A., Lukasik, J., Menendez, P. & Scott, T.M., (2004). Reduction of pathogens, indicator bacteria, and alternative indicators by wastewater treatment and reclamation processes. *Water Environment Research Foundation Report 00-PUM2T*.
- Rowe, W.P., Huebner, R.J., and Gillmore, L.K. (1953) Isolation of cytopathogenic agent from

- human adenoids undergoing spontaneous degeneration in tissue culture. *Proc. Soc. Exp. Biol. Med.*, 84:570-573.
- Roy, S.L., Scallan, E., and Beach, M.J. (2006). The rate of acute gastrointestinal illness in developed countries, *Journal of Water and Health*, 04, Suppl., 31-69
- Sanaa, M., Bemrah, N., Meyer, S., Cerf, O., and Mohammed, H. (2000). "Quantitative risk assessment related to microbial food contamination" *Revue D' Epidemiologie et De Sante Publique*, 48(SUPP2), 11-23.
- Sobsey, M., Battigelli, D., Handzel, T., and Schwab, K. (1995). *Male-specific coliphages as indicators of viral contamination of drinking water*, AWWA Research Foundation.
- Soller, J.A., Eisenberg, J.N., and Olivieri, A.W. (1999). Evaluation of pathogen risk assessment framework. Technical Report Prepared by EOA Inc., and U.C. Berkeley for ILSI Risk Science Institute, 1999.
- Soller, J. A., Olivieri, A., Crook, J., Parkin, R., Spear, R., Tchobanoglous, G., and Eisenberg, J. N. S. (2003a). "Risk-based Approach to Evaluate the Public Health Benefit of Additional Wastewater Treatment," *Environ. Sci. Technol.*, 37(9), 1882-1891.
- Soller, J., A.W. Olivieri, R. Spear, and D. Dodge, (2003b). "Characterizing the Public Health Risk from Recreating in Treated Wastewater: A Dynamic Model of Disease Transmission APHA 2003 Annual Conference (Paper #35148).
- Soller, J.A., Turbow, D. and Olivieri, A.W. (2003c). "Characterization of the Potential Adverse Human Health Effects Associated with Combined Sewer Overflows and Sanitary Sewer Overflows Prepared by EOA, Inc. for Association of Metropolitan Sewerage Agencies.
- Soller, J., A. Olivieri, J.N.S. Eisenberg, R. Sakaji, and R. Danielson. (2004). "Evaluation of Microbial Risk Assessment Techniques and Applications," Water Environment Research Foundation, Project 00-PUM-3, Final Project Report.
- Soller, J.A., J.N.S. Eisenberg, J. DeGeorge, R. Cooper, G. Tchobanoglous, and A.W. Olivieri. (2006), "A Public Health Evaluation of Recreational Water Impairment", *Journal of Water and Health*, 4(1), 1-23.
- Tanaka, H., Asano, T., Schroeder, E. D., and Tchobanoglous, G. (1998). "Estimating the safety of wastewater reclamation and reuse using enteric virus monitoring data." *Water Environ Res*, 70(1), 39-51.
- Teunis, P., Takumi, K. & Shinagawa, K., (2004) Dose response for infection by Escherichia coli O157:H7 from outbreak data. *Risk Anal* 2004, 24, (2), 401-7.
- Teunis, P.F. & Havelaar, A.H., (2000) The beta poisson dose-response model is not a single-hit model. *Risk Analysis* 2000, 20, (4), 513-21.
- Teunis, P.F.M., Medema, G.J., Kruidenier, L. & Havelaar, A.H., (1997) Assessment of the risk of infection by Cryptosporidium or Giardia in drinking water from a surface water source. *Water Res.* 1997, 31, (6), 1333-46.
- Teunis, P.F.M., van der Heijden, O.G., van der Giessen, J.W.B. & Havelaar, A.H., (1996) The dose-response relation in human volunteers for gastro-intestinal pathogens. *RIVM Report* 1996, 284550002.

- Teunis, P.F.M., et al., (2008). *Norwalk virus: How infectious is it?* Journal of medical virology, 2008. 80(8): p. 1468-1476.
- U.S. EPA. (1986). Ambient water quality criteria for bacteria, EPA440/5-84-002.
- U.S. EPA. (1991) Technical Support Document Water Quality-based Toxics Control. Office of Water, Vol. EPA/505/2-90-001.1991.
- U.S. EPA. (1997). Exposure Factors Handbook. Office of Research and Development, NCEA.1997.
- U.S. EPA. (2003). CSFII analysis of food intake distributions, EPA-600-R-03-029. Washington, D.C.2003.
- U.S. EPA. (2006). National primary drinking water regulations: Long term 2 enhanced surface water treatment rule (LT2ESWTR); final rule., Vol. 40CFR Parts 9, 141 and 142, volume 71, Number 654, January 5, 2006.2006.
- van Ginneken, M. and Oron, G., (2000). Risk assessment of consuming agricultural products irrigated with reclaimed wastewater: An exposure model. *Water Resources Res* 2000, 36, (9), 2691-99
- Voysey, P. A., and Brown, M. (2000). "Microbiological risk assessment: a new approach to food safety control" *International Journal of Food Microbiology*, 58(3), 173-179.
- Ward, R.L., Bernstein, D.I., Young, E.C., Sherwood, J.R., Knowlton, D.R. and Schiff, G.M. (1986). Human rotavirus studies in volunteers: determination of infectious dose and serological response to infection. *J Infect Dis*, 154(5): 871-79.
- Wade, T.J., Pai, N., Eisenberg, J.N.S., and Colford, J.M. (2003). "Do US EPA Water Quality Guidelines for Recreational Waters Prevent Gastrointestinal Illness? A Systematic Review and Meta-Analysis. *Environmental Health* (available at <http://dx.doi.org/>).
- World Health Organization (1999). Health based monitoring of recreational waters: the feasibility of a new approach (The 'Annapolis Protocol'), WHO/SDE/WSH/99.1, Geneva.
- World Health Organization (2004). *Guidelines for Drinking Water Quality*, 3rd ed., World Health Organization, Geneva.
- Yamamoto, G.H., (2010) California Department of Public Health letter to Assistant Executive Officer K.D. Landau, central valley Water Board, June 15, 2010.
- Yamamoto, G.H., (2010) California Department of Public Health letter to Assistant Executive Officer K.D. Landau, central valley Water Board, June 15, 2010.

4.0 REVIEW OF KEY CDPH WATER RECYCLING CRITERIA PERFORMANCE STANDARDS

As discussed previously, the Panel was provided with a summary of a number of specific CDPH concerns (see Appendix 1-2) for the purpose of informing the Panel of the specific issues that collectively may warrant the Panel's review. The Panel reviewed and discussed the CDPH summary and developed the following list of priority questions that it felt were within the Panel's charge:

- Basis for 5-log reduction.
- Basis for 450 CT.
- Define multiple barriers.
- Relevance of ≤ 2 NTU.
- Defining secondary treatment.
- Relevance of total coliforms.
- Uptake by crops of pathogenic viruses.

The following discussion provides a statement of question, and the Panel's analysis and finding(s). Note that Question Numbers 1 and 2 are addressed in Section 3.0.

4.1 Question No. 3: What Is the Basis for the Current 5-Log Virus Reduction Criteria? Is the Criterion Still Relevant?

and

Question No 4: What Is the Basis for the 450-mg/min/L CT Requirement?

Prior to adoption of the CDPH Water Recycling Criteria in 2000 (State of California, 2000), recycled water treatment and quality criteria did not include disinfection requirements expressed in terms of either CT or virus removal. Both the 1975 and 1978 versions of the Wastewater Reclamation Criteria (State of California, 1975; 1978) included the following treatment and disinfection requirements for the spray irrigation of food crops:

“60302. Spray Irrigation. Reclaimed water used for the spray irrigation of food crops shall be at all times an adequately disinfected, oxidized, coagulated, clarified, filtered wastewater. The wastewater shall be considered adequately disinfected if at some location in the treatment process the median number of coliform organisms does not exceed 2.2 per 100 milliliters and the number of coliform organisms does not exceed 23 per 100 milliliters in more than one sample within any 30-day period. The median value shall be determined from the bacteriological results of the last 7 days for which analyses have been completed.”

CT Requirement: In the mid-1970s, the Sanitation Districts of Los Angeles County initiated a study to evaluate alternative treatment trains to the train required in the Wastewater Reclamation Criteria. The study, known as the Pomona Virus Study (Sanitation Districts of Los Angeles County, 1977), evaluated the following treatment trains:

System A: Alum coagulation, flocculation, sedimentation, filtration, disinfection (Wastewater Reclamation Criteria treatment train).

System B: Low dose alum coagulation, filtration, disinfection (abbreviated treatment train, also known a “direct filtration”).

System C: Carbon adsorption, disinfection, carbon adsorption.

System D: Low dose alum coagulation, filtration, disinfection (nitrified effluent feed).

Both ozone and chlorine were tested as the disinfectant. Only the results for chlorine disinfection are discussed here. The pilot plant treatment trains for Systems A and B, which are the most common in California, are shown in Figures 4.1 and 4.2. The differences between Systems A and B are that the coagulant dose was reduced from 150 milligram per liter (mg/L) to 5 mg/L in System B, and the flocculation and sedimentation steps were eliminated. Tracer studies determined that the modal chlorine contact time for both systems was about 98 minutes, both had combined chlorine residuals at the end of the chlorine contact retention time, and both met the total coliform requirements specified in the 1975 Wastewater Reclamation Criteria.

Seeded attenuated polio virus was injected into a secondary effluent line feeding each system. The cumulative log removals of poliovirus for all of the tertiary systems evaluated are shown in Figures 4.3 and 4.4. Chlorine addition was adjusted to produce combined residuals of approximately either 5 mg/L or 10 mg/L at the end of the chlorine contact tanks. Virus monitoring results indicated that the cumulative log virus removal was approximately 5 logs (some slightly below that level and some slightly above that level) in all of the systems having 5-mg/L or 10-mg/L combined chlorine residuals.

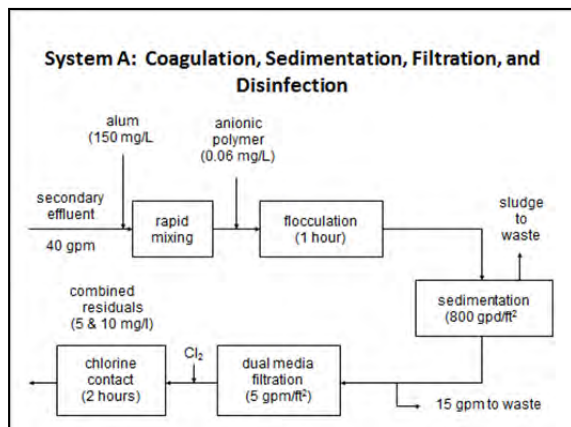

Figure 4.1 1978 wastewater reclamation treatment train.

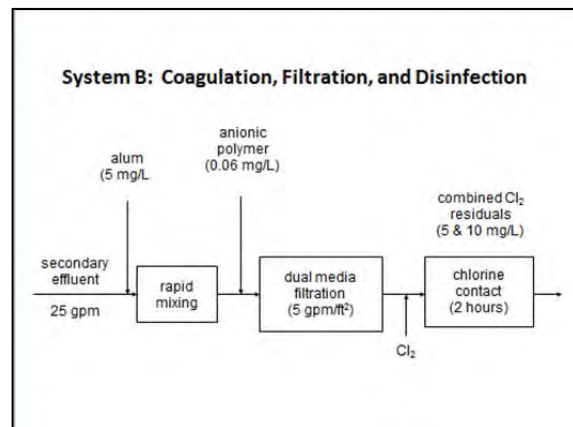

Figure 4.2 Abbreviated treatment train. Criteria treatment train.

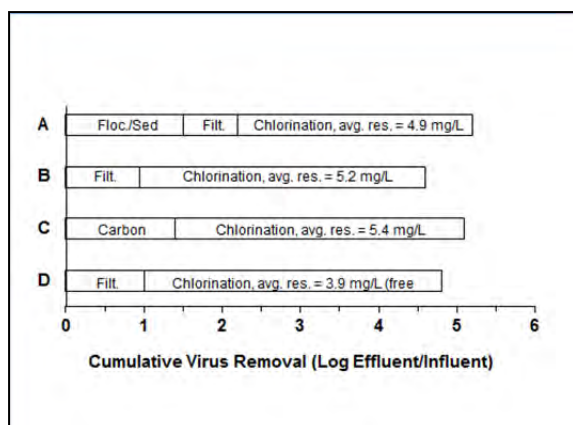

Figure 4.3. Polio virus removal for chlorine residual ~ 5 mg/L.

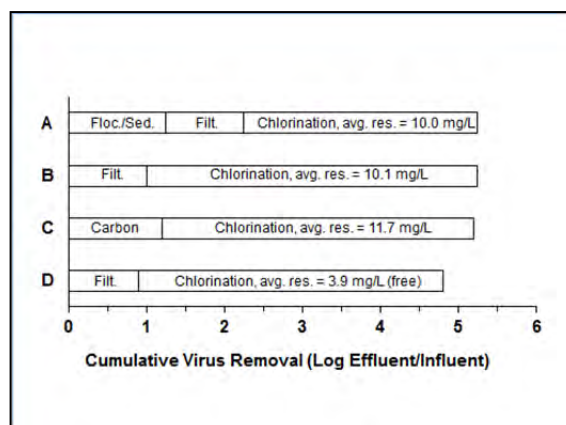

Figure 4.4. Polio virus removal for chlorine residual ~ 10 mg/L.

Upon completion of the Pomona Virus Study²³, CDPH initially recommended that several specific design and operational requirements be followed when employing the alternative methods of treatment that were studied at Pomona, including a combined chlorine residual of 10 mg/L and a modal chlorine contact time of at least 98 minutes. SWRCB requested that CDPH reconsider these preliminary requirements based on operating data from Los Angeles County Sanitation plants and the Pomona Virus Study. Upon review of the data, CDPH determined that, where the basic design and water quality conditions achieved during the Pomona Virus Study are met, an adequate degree of public health protection can be provided without reference to a specific chlorine residual (California Department of Health, 1978). System B (abbreviated treatment train) was determined to be equivalent to System A (i.e., the treatment train required in the 1978 Wastewater Reclamation Criteria) if the following conditions were met:

1. Turbidity in the secondary effluent of less than 10 turbidity units.
2. Coagulation ahead of the dual media filters.
3. Comparable filter depths and loading rates to those used during the Pomona Virus Study.
4. Average turbidity in the filtered effluent of less than or equal to 2.0 turbidity units.
5. High energy rapid mix of chlorine.
6. Theoretical contact time of 2 hours and a modal time between 90 to 100 minutes, based on peak dry weather flow.
7. Chlorine contact chamber length to depth or width ratio of 40:1.
8. Median (2.2/100 mL) and maximum (23/100 mL) total coliform requirements.

CDPH subsequently determined that – for alternative treatment processes to be used in lieu of the requirements in the 1978 Wastewater Reclamation Criteria that require an adequately disinfected, oxidized, coagulated, clarified, filtered wastewater – a chlorine residual was

²³ Virus monitoring by the County Sanitation Districts of Los Angeles County (Yanko, 1993) and the Monterey Regional Water Pollution Control Agency (Jaques et al., 1999) at full-scale operational tertiary treatment plants meeting the CT and other requirements specified in the Water Recycling Criteria for disinfected tertiary recycled water did not detect naturally occurring pathogenic viruses in the treated recycled water.

necessary to ensure adequate disinfection. In 1978, CDPH published a policy statement (Policy Statement for Wastewater Reclamation Plants with Direct Filtration) that required a chlorine residual of at least 5 mg/L after a modal contact time of at least 90 minutes (California Department of Health Services, 1988), which resulted in a minimum allowable CT of 450 mg-min/L. The CT and modal contact time requirements ultimately were incorporated into the 2000 revision of the 1978 criteria. The Final Statement of Reasons (California Department of Health Services, 1999) prepared prior to adoption of the 2000 CDPH Water Recycling Criteria (State of California, 2000) included the following rationale for requiring a minimum CT of 450 mg-min/L after a minimum contact time of 90 minutes:

“Proposed section 60301.230 would be adopted to define a wastewater that has been ‘adequately disinfected, oxidized, coagulated, clarified, and filtered’; these terms are used in the existing sections 60303 through 60305. This definition contains specific proposed criteria relating to the disinfection process. Existing regulations (sections 60303 through 60317) specify a median concentration of coliform bacteria of 2.2 per 100 milliliters and a maximum of 23 coliform per 100 milliliters which may be exceeded in only one sample within a 30 day period. These bacterial requirements are unchanged in the proposed regulations but are made a part of the definition for greater clarity. The existing regulation does not specify a maximum for the one sample exceedance. The Department believes that this should not be unlimited because it could create a short period of substantial contamination to users. A maximum of 240 MPN has been inserted for the one sample exceedance. This would allow ample operational flexibility without creating an unreasonable risk to the public.

Currently, the term ‘adequate disinfection’ is defined strictly in terms of coliform concentrations. The Department does not believe this provides sufficient reliability for inactivation of viruses. A report on a major study of the effectiveness of wastewater treatment processes in controlling viruses (the Pomona Virus Study) was released in February 1977. That report made specific technical recommendations on minimum disinfection concentration and contact time necessary to control viruses. Since the release of that study, the Department has used those recommendations as the basis for comments to the regional water quality control boards on proposed recycling project requirements, to ensure adequate public health protection when recycled water is used. Proposed section 60301.230, therefore, also adds a requirement for a minimum chlorine concentration versus time (generally referred to as CT values) of 450 based on a minimum 90-minute contact time. These requirements are based on the Department's experience with several demonstration projects (including the 1977 report on the Pomona Virus Study) where these concentrations and detention times were shown to be effective in inactivating viruses and on operational testing data submitted by the Los Angeles County Sanitation Districts. An alternative disinfection method can be used provided that it is demonstrated to be capable of removing or inactivating viruses to a level of 1/100,000 (5 logs) of the initial concentration. The demonstration of a 5 log reduction or use of the specified CT values were determined by the Department to be necessary to assure effective and reliable removal and inactivation of enteric viruses for those uses where the public exposure to the recycled water is exceptionally high.”

The current CDPH Water Recycling Criteria (State of California, 2000) require that recycled water used for the irrigation of food crops where the recycled water comes in contact with the edible portion of the crop must be an oxidized, filtered, and disinfected wastewater that meets the definition of “disinfected tertiary recycled water” in the criteria, as follows:

“Section 60301.230. Disinfected Tertiary Recycled Water.

“Disinfected tertiary recycled water” means a filtered and subsequently disinfected wastewater that meets the following criteria:

- (a) The filtered wastewater has been disinfected by either:
 - (1) A chlorine disinfection process following filtration that provides a CT (the product of total chlorine residual and modal contact time measured at the same point) value of not less than 450 mg-min/L at all times with a modal contact time of at least 90 minutes, based on peak dry weather flow; or
 - (2) A disinfection process that, when combined with the filtration process, has been demonstrated to inactivate and/or remove 99.999 percent of the plaque-forming units of F-specific bacteriophage MS2, or polio virus in the wastewater. A virus that is at least as resistant to disinfection as polio virus may be used for purposes of the demonstration.
- (b) The median concentration of coliform bacteria measured in the disinfected effluent does not exceed an MPN of 2.2 per 100 mL utilizing the bacteriological results of the last 7 days for which analyses have been completed and the number of total coliform bacteria does not exceed an MPN of 23 per 100 mL in more than one sample in any 30-day period. No sample shall exceed an MPN of 240 total coliform bacteria per 100 mL.”

Panel Findings:

1. Based on seeded polio virus studies on tertiary treatment using direct filtration (Pomona Virus Study [Sanitation Districts of Los Angeles County, 1977] and Monterey Wastewater Reclamation Study for Agriculture [Engineering-Science, 1987]) and other data from operational water reclamation facilities in California, the Panel concurs with CDPH that – for irrigation of food crops eaten raw – requiring a CT of 450 mg-min/L for disinfected tertiary recycled water (or a 5-log inactivation/removal of poliovirus or MS2 through filtration and disinfection²⁴) is appropriate. This is not meant to imply that alternative treatment technologies and/or different CTs would not ensure adequate health protection; however, studies would be needed to document that an equivalent level of health protection would be provided by the alternative treatment technologies or CTs (e.g., see Finding 2 below).

²⁴ Please note that achieving a 5-log reduction relying on MS2 is not feasible based on available data (EOA and Public Health Institute, 2007; Olivieri et al., 1998 [see Appendix 4-1 for data and inactivation curves]). This is the case since MS2 is more resistant to combined chlorine than poliovirus.

2. The CT requirement specified in the Water Recycling Criteria principally is based on the Pomona Virus Study, which used combined chlorine and a modal contact time of about 90 minutes, seeded with poliovirus I. It would be worthwhile for the water industry to commission a follow-up study to determine whether the use of free chlorine at different modal contact times would be able to achieve 5 logs of seeded virus removal at lower chlorine contact times, thus resulting in lower CT requirements.²⁵
3. The Panel recognizes that the drinking water regulations allow a lower CT to demonstrate 5 logs of virus removal, but is of the opinion that it is inappropriate to use drinking water CT criteria for recycled water because recycled water is more complex than drinking water, and a safety factor is needed.

References for Questions 3 and 4

California Department of Health (1978). Memorandum from Henry Ongerth, California Department of Health, to Neil Dunham, State Water Resources Control Board, April 18, 1978.

California Department of Health Services (1988). *Policy Statement for Wastewater Reclamation Plants with Direct Filtration*. California Department of Health Services, Environmental Management Branch, Sacramento, California.

California Department of Health Services (1999). *Final Statement of Reasons, Water Recycling Criteria, Chapter 3. Water Recycling Criteria*. California Department of Health Services, Sacramento, California.

Darby, J., A. Olivieri, C. Tang, and A. Salveson (2006). *Pathogen Removal and Inactivation in Reclamation Plants – Study Design (WRF-03-001)*, WateReuse Research Foundation, Alexandria, Virginia.

EOA, Inc. and Public Health Institute (2007). Microbial Challenge Studies and Estimation of Process Train Performance, report prepared for City of San Diego – Aqua 2000 Research Center, December 2007.

Engineering-Science (1987). *Monterey Wastewater Reclamation Study for Agriculture: Final Report*. Prepared for the Monterey Regional Water Pollution Agency by Engineering-Science, Berkeley, California.

Jaques, R.S., G.M. Antonz, R.C. Cooper, and B. Sheikh (1999). Pathogen Removal Effectiveness of a Full-Scale Recycling Plant. In: *Proceedings of WEFTEC '99*, October 9-13, 1999, New Orleans, Louisiana.

Olivieri, A., Eisenberg, D., Soller, J., Danielson, R., Cooper, R., Adham, S., and Gagliardo, P. (1998). Microbial Challenge Studies at the Aqua 2000 Research Center, presented at the AWWA-WEF Joint Conference, Water Reuse 98, Lake Buena Vista, FL.

²⁵ It would be useful for CDPH to review the elements of such a study as described in the WRRF report (WRF-03-01) by Darby et al., 2006.

Sanitation Districts of Los Angeles County (1977). *Pomona Virus Study: Final Report*. Report prepared by the Sanitation Districts of Los Angeles County for the California State Water Resources Control Board, Sacramento, California.

State of California (1975). *Wastewater Reclamation Criteria*. California Administrative Code, Title 22, Division 4, California Department of Health, Water Sanitation Section, Berkeley, California.

State of California (1978). *Wastewater Reclamation Criteria*. California Administrative Code, Title 22, Division 4, California Department of Health Services, Sanitary Engineering Section, Berkeley, California.

State of California (2000). *Water Recycling Criteria*. California Code of Regulations, Title 22, Division 4, Chapter 3. California Department of Health Services, Sacramento, California.

Yanko, W.A. (1993). Analysis of 10 Years of Virus Monitoring Data from Los Angeles County Treatment Plants Meeting California Wastewater Reclamation Criteria. *Water Environ. Research.*, 65(3):221-226.

4.2 Question No. 5: How Should Multi-Barrier Treatment and Effectiveness Be Defined? How Should It Be Evaluated?

The primary concern of wastewater treatment for reuse for agricultural irrigation is the inactivation or removal of pathogenic microorganisms. Within the typical water reclamation process train, although primary treatment, secondary treatment, and filtration can all provide removal of pathogens, the burden of pathogen removal or inactivation lies with disinfection (see Figures 3.3 and 3.4 on the Pomona Virus Study).

A simple approach to a multiple barrier is to provide a process train of multiple units that provides a high level of performance such that the treatment train can meet the overall removal goal even if the most effective single unit process fails. However, this approach generally is not useful for most nonpotable uses of recycled water, since disinfection is the key step in the treatment of recycled water for such uses, and total failure of the disinfection process will almost always result in product water that does not meet microbial requirements. A better approach is to focus on the reliability and control of the disinfection process.

4.3 Question No. 6: Is the Current <2 NTU (Average Daily) Turbidity Criteria Still a Valid Filtration Performance Standard?

The removal of suspended matter in wastewater to be used for crop irrigation is related to health protection as particulates can shield pathogens from disinfectants such as chlorine and ultraviolet radiation. In California, turbidity is used as the measure of particulates in recycled water. Turbidity, by itself, is not used as an indicator of microbial quality, but rather as a quality criterion prior to disinfection. Disinfection capability is inversely related to turbidity (i.e., the lower the turbidity, the greater the level of disinfection for any particular disinfectant dose).

Turbidity requirements first appeared in California's water reuse regulations in the 1968 Statewide Standards for the Safe Direct use of Reclaimed Waste Water for Irrigation and Impoundments (State of California, 1968). Those regulations required that the turbidity of filtered effluent not exceed 10 turbidity units. Prior to revision of the 1968 standards, CDPH evaluated data from several tertiary wastewater treatment facilities in California and elsewhere (California Department of Health, 1974) and determined that establishment of a more conservative standard was required to ensure that effective coagulation and filtration has taken place. Thus, turbidity requirements in the 1975 and 1978 Wastewater Reclamation Criteria were more restrictive than those in the 1968 standards and required that turbidity after filtration "does not exceed an average operating turbidity of 2 turbidity units and does not exceed 5 turbidity units more than 5 percent of the time during any 24-hour period" (State of California, 1975; State of California, 1978).

The 2000 California Water Recycling Criteria (State of California, 2000) further revised the turbidity requirements (that apply to treated wastewater after media filtration) to include a maximum turbidity that cannot be exceeded at any time, determination of turbidity as NTU, and other minor changes for clarity. The 2000 criteria require that the turbidity of filtered wastewater cannot exceed an average of 2 NTU within a 24-hour period, 5 NTU more than 5 percent of the time within a 24-hour period, and 10 NTU at any time. The criteria also include turbidity requirements for wastewater that has received treatment via microfiltration, ultrafiltration, nanofiltration, or reverse osmosis membranes that are considerably more restrictive than those that apply to wastewater that has received media filtration (i.e., the turbidity cannot exceed 0.2 NTU more than 5 percent of the time within a 24-hour period and cannot exceed 0.5 NTU at any time). The Final Statement of Reasons (California Department of Health Services, 1999) for the Water Recycling Criteria included the rationale for the turbidity requirements, as follows:

"Subsection (r) would be re-designated as new section 60301.320. The wording would be changed to remove the clarification unit process requirement from this definition. The existing requirement would be adequately covered by other definitions and is unnecessary. A maximum turbidity limit of 10 NTU would be adopted into the previous definition. The existing definition allows the 2 NTU daily average to be exceeded up to 5 percent of the time. Not specifying an absolute maximum, however, would allow a treatment facility to produce an effluent with unlimited turbidity 5 percent of the time. This could cause the disinfection process to be ineffective for short periods. Imposing a 10 NTU maximum would preclude this possibility while not imposing unreasonable operational restrictions on existing plants. Existing plants that are well operated have demonstrated the capability to meet this requirement consistently. Other minor changes would be made in this section for greater clarity, such as specifying that "of the time" refers to a 24-hour period.

Subsection 60301.320(b) requires the use of filtration technologies with membranes to physically screen particulate matter, including certain pathogens (microfiltration, ultrafiltration, nanofiltration, and reverse osmosis). Membrane filtration has been demonstrated to achieve virus removal when the turbidity performance objectives in this subsection have been met."

The more restrictive turbidity requirement for membranes is based on observed turbidity levels

in product water from properly designed and operated microfiltration unit processes having a nominal pore size in the 0.1- to 0.2- μ m range and reflects attainability and good engineering practices.²⁶

Panel Findings:

1. The Panel concurs with the turbidity requirements in the Water Recycling Criteria for wastewater that has received media filtration.
2. While the Panel understands the rationale for the more restrictive turbidity requirements where membranes are used in place of media filters, as attainability and good practice has always been considered during development of water recycling criteria through the years, we are of the opinion that more information is necessary to document the need for the low turbidity requirements when membranes are used in place of media filters. For example, it would be important to find out whether membrane treatment that produces wastewater meeting a turbidity limit of 2 NTU indicates that more pathogens are present in the wastewater before disinfection than that for media filtration meeting the same turbidity limit.

References for Question No. 6

- California Department of Health (1974). *Turbidity Standard for Filtered Wastewater*. State of California Department of Health, Water Sanitation Section, Berkeley, California.
- California Department of Health Services (1999). *Final Statement of Reasons, Water Recycling Criteria, Chapter 3. Water Recycling Criteria*. California Department of Health Services, Sacramento, California.
- State of California (1968). *Statewide Standards for the Safe Direct Use of Reclaimed Water for Irrigation and Recreational Impoundments*. California Administrative Code, Title 17, Group 12, California Department of Public Health, Berkeley, California.
- State of California (1975). *Wastewater Reclamation Criteria*. California Administrative Code, Title 22, Division 4, California Department of Health, Water Sanitation Section, Berkeley, California.
- State of California (1978). *Wastewater Reclamation Criteria*. California Administrative Code, Title 22, Division 4, California Department of Health Services, Sanitary Engineering Section, Berkeley, California.
- State of California (2000). *Water Recycling Criteria*. California Code of Regulations, Title 22, Division 4, Chapter 3. California Department of Health Services, Sacramento, California.

²⁶ The Panel is not aware of data for evaluating disinfected recycled water at turbidities slightly above or slightly below 2 NTU. Thus, the Panel had no basis for determining an “optimized turbidity level.” Further, the existing turbidity requirements are readily achievable at well-operated water reclamation facilities and have been shown to provide an acceptable level of public health protection in combination with the CT and disinfection requirements. Finally, the Panel’s task was to evaluate the adequacy of the existing Water Recycling Criteria for agricultural applications, not to propose criteria over and above that needed to safeguard public health.

4.4 Question No. 7: Should Performance Standards Be Used to Define/Characterize Secondary Treatment?

The Water Recycling Criteria use the term “oxidized wastewater” instead of “secondary treatment.” Oxidized wastewater is defined as wastewater in which the organic matter has been stabilized, is nonputrescible, and contains dissolved oxygen. Although not specifically stated in the regulations, it is generally interpreted as requiring biological treatment. The definition of oxidized wastewater is vague and contains no numerical limits that must be met, whereas the EPA defines secondary treatment as having to meet the following requirements: 30 mg/L biochemical oxygen demand (BOD) (30-day average); 30 mg/L total suspended solids (TSS) (30-day average); pH in the 6 to 9 range; and at least 85 percent removal of BOD and TSS (30-day average).

Panel Findings:

1. Upon the next revision of the Water Recycling Criteria, it is recommended that the term “oxidized wastewater” be replaced with “stabilized wastewater” and numerical limits are connected to the term “stabilized wastewater.” The EPA secondary treatment numerical limits would be logical values. “Stabilized” is a more inclusive and accurate term when considering emerging technologies and the goals of wastewater treatment. Newer technologies (e.g., low-pressure membrane treatment) will allow physical-chemical treatment of primary effluent and will also allow for anaerobic biological treatment. Both of these treatment approaches can have significant advantages over traditional aerobic biological treatment with respect to energy use and energy recovery from residual solids. These emerging process approaches may eventually meet numerical limits for secondary treatment, but may not meet the current definition of oxidized wastewater. A change in terminology would allow for the development of future process trains to be more easily accepted into use if the effluents from these process trains meet specified water quality limits.
2. Until the recycling criteria are revised, the above-finding can be implemented by CDPH via use of Section 60320.5 (other methods of treatment) in the Water Recycling Criteria. This section states: “Methods of treatment other than those included in this chapter and their reliability features may be accepted if the applicant demonstrates to the satisfaction of the State Department of Health that the methods of treatment and reliability features will assure an equal degree of treatment and reliability.”

4.5 Question No. 8: Are Total Coliforms Still an Appropriate Indicator of Overall Disinfection Performance?

One of the questions the Panel was asked to address was: Are total coliforms still an appropriate indicator for overall disinfection performance in the treatment of wastewater to be used for unrestricted irrigation of food crops? The answer is a qualified yes. The use of coliforms as indicators of the sanitary quality of water has had a successful history for more than a century with particular application to monitoring drinking water. The public health experience in the wastewater reuse arena, especially in protecting recreationists in direct contact with reclaimed

water, has been positive. The use of reclaimed water for unrestricted food crop irrigation has less of a history, but experience to date has also been positive. A low level of total coliforms in treated effluents has proven to be an adequate indicator of the performance (reduction of microbial agents) by an entire treatment process. The ability of a treatment plant to consistently produce water that consistently meets total coliform standards has been the key to the protection of the public health.

At this point in time, we have no practical and time-proven alternative to the coliform standard. Subsets of the total coliform group have been suggested as being more indicative of sanitary quality (i.e., fecal coliform and *Escherichia coli* for which recognized assay methods are available). The total coliforms are the most conservative indicator of plant performance, followed closely by the fecal coliform and *E. coli* in that order.

The development of new indicator assay and identification methods are in the wings, but thus far are not practical for routine monitoring or shown to be superior to the coliform culture standard.

Brief Coliform Indicator History: The bacterium *Escherichia coli* was first isolated by Theodore Escherich (Oberbauer, 1992), a renowned Austrian pediatrician interested in infectious diseases, who, circa 1884, isolated a bacterium from infant feces that he named *Bacillus coli commune*.²⁷ It was subsequently recognized to be common in the feces of all healthy humans. Since the discovery that intestinal disease-producing microorganisms can be distributed through the medium of drinking water, it became imperative to be able to monitor for the presence of these agents; however, there was no practical way to determine the presence of this potential myriad of pathogenic bacterial types. As these diseases are all associated with infected feces, it was soon understood that even though *E. coli* was not considered a pathogen, its ubiquity in fecal matter made it a good indicator for the presence of that material and any drinking water exhibiting this factor was potentially dangerous to the public's health. This led to the development of a practical method for routine monitoring of this bacterium in water. As assay methods were developed, it became apparent that methods aimed at the recognition and enumeration of *E. coli* were not exclusive and that other bacteria with similar metabolic characteristics could also be present in a water sample. This was the genesis of the term *total coliform*, which is defined as any gram negative, non-spore forming rod that fermented lactose with the production of gas when incubated at 35°C. Through the years, test media have been developed that are aimed at limiting the bacteria that grow in test media to those that fit the total coliform definition, as well as those that are more likely to be of fecal origin, called fecal coliforms, and for the isolation and enumeration of *E. coli* specifically.

Relationship of Coliforms with Disease Agents: There is a common misconception that coliform concentrations in water should demonstrate a positive correlation with the presence and number of infectious disease agents. Frequently, one sees references to the criteria for an ideal indicator microorganism that states they be present when human pathogens are present and absent when they are not. As stated previously, it was understood a century ago that the presence of coliforms in water is a measure of the presence of fecal matter that might contain

²⁷ The *Bacterium coli commune* was re-named *Escherichia coli* in honor of Dr. Escherich in 1919 (8 years after his death). The name was not officially accepted by the Commission of the International committee on Bacteria Nomenclature until 1958.

some level of human pathogens. The actual level of pathogens that might be present fluctuates as a function of the intestinal disease morbidity in the community that is the source of the sewage.

California Experience: In California, interest in the permitted use of wastewater for agricultural irrigation started as early as 1906 (California State Board of Health Bulletin, 1906). Initially, the health authorities began regulating such practices by limiting human access and limiting the types of crops to which the water could be applied. One of the earliest references to a coliform standard applied to sewage-associated irrigation water was in the California Department of Health regulations titled, *Regulation on the Use of Sewage for Irrigating Crops*, issued in 1933 (California Department of Public Health, 1933), in which the Department allowed the irrigation of truck crops if the wastewater was oxidized (made non-putrescible) and reliably disinfected or filtered to meet bacterial standards approximately the same as the current drinking water standard (i.e., an MPN less than 2.2 coliform per 100 mL).²⁸ Through steady revisions, the regulations – commonly referred to as “Title 22,” but more appropriately called “water recycling criteria” (State of California, 2000) – evolved, which require a specific treatment train, producing a total coliform level of <2.2 MPN/100 mL in the effluent.

In the 1950s, polio virus was isolated from municipal sewage. This finding, plus indications that certain enteric viruses appeared to be more resistant to chlorine disinfection, set off a concerted effort to find viruses in water and wastewater. At that time, the means of detecting viruses in wastewater was limited to non-quantitative presence-absence methods.²⁹ By the 1960s, methods to concentrate and enumerate viruses from large volume samples were developing, and it was soon understood that their numbers in wastewater, compared to coliforms, were very low. Coliforms occur consistently at about 1×10^7 MPN/100 mL of untreated sewage, while total culturable virus levels in raw sewage are frequently reported in the range of 100 plaque forming units (pfu) per liter (L). This is at least a six to seven order of magnitude difference from the total coliform numbers in raw sewage. Understandably, the numbers expected in treated effluents will be considerably smaller. Because of the large sample volume required to detect and measure *in situ* viruses in tertiary effluents, their numbers are reported as per multiple liters,³⁰ while coliform values are reported as per 100 mL. The virus concentration methods developed became the Standard Method and have basically remained unchanged to the present time.

Close human contact with reclaimed wastewater, primarily through recreation, was of particular concern to CDPH. In 1975, the California Wastewater Reclamation Criteria (State of California, 1975) were promulgated for the use or discharge of reclaimed water in which significant human contact was likely. The criteria required a treatment train that included secondary treatment followed by chemical coagulation, sedimentation, filtration, and disinfection, a process that closely mirrored drinking water treatment. The filtered wastewater was required to have an average turbidity of ≤ 2 NTU with no values to exceed 5 NTU, and the disinfected wastewater

²⁸ Non-detect in a standard MPN test of five tubes each inoculated with 10 mL of sample.

²⁹ Viruses were concentrated onto absorbent pads, called Moor Pads, that were suspended in flowing sewage for various amounts of time after which the viruses were extracted and the extract assayed for the presence of viruses.

³⁰ Virus levels are frequently reported as plaque forming units (pfu) per 100 L.

was required to have median total coliform levels not exceeding 2.2 MPN per 100 mL (non-detect).³¹ If these criteria were met, the reused water would be considered “virtually pathogen free.” This “pathogen free” assumption was not unreasonable since these water treatment processes had a long history of successfully treating drinking water from frequently unsavory raw water supplies and protecting public health.

Title 22 Coliform Requirement and Virus Reduction: The Pomona Study (Sanitation Districts of Los Angeles County, 1977): The Pomona Virus Study was conducted from 1976 through June 1977. The Sanitation Districts of Los Angeles County discharged their disinfected effluent into local streams that were also used for recreation. CDPH water reuse regulations required that the Districts would need to upgrade the treatment process to meet the new criteria. The Districts wanted to determine if other less costly treatment methods could be substituted. To do so, CDPH required that they demonstrate the alternative method would be able to meet the 1978 Wastewater Reclamation Criteria water quality objectives (State of California, 1978), including demonstration of equivalent virus reduction capability. *Up to this time, the virus removal capability of the full treatment train specified in the regulations had not been ascertained.*

The Districts proposed to compare, at a pilot scale, the treatment requirements (oxidation, coagulation, clarification, filtration, and disinfection) and quality requirements (≤ 2.2 total coliform organisms/100 mL and ≤ 2 NTU) in the 1978 Wastewater Reclamation Criteria with a number of alternative treatment schemes, including direct filtration.³² Because of low numbers of *in situ* viruses in the secondary effluent, the study was conducted by seeding with a vaccine strain of polio virus. As noted in Section 4.1 (see Panel response to *Question No 4. What is the Basis for the 450 mg/min/L CT Requirement?*), the seeding studies indicated that the treatment regime in the 1978 criteria, augmented with a 2-hour theoretical chlorine contact time (which resulted in a 98-minute modal contact time) having a combined chlorine residual³³ of 4.9 mg/L, resulted in a 5-log reduction in virus. The 2-hour contact time was selected because the Districts, through experience and calculation, found that this was required to economically achieve a ≤ 2.2 coliform MPN per 100 mL in tertiary effluent. The study indicated that a CT³⁴ of 450, applied to disinfection of the effluent, met the coliform standard and concomitantly would reduce the virus level by 5 logs. From this study, the CDPH chlorination requirement of a CT of 450 originated. In actuality, the 5-log reduction in virus requirement for alternative treatment systems is based on a total coliform reduction to ≤ 2.2 MPN/100 mL in Pomona’s tertiary effluent.

Treatment Aspects: The intestinal bacterial pathogens will react to environmental phenomena, including water treatment, in much the same manner as coliforms. Thus, the rates of removal of coliforms should be indicative of the ability of a treatment process to remove bacterial pathogens. The animal viruses also respond to most conventional treatment processes (Title 22

³¹ The total coliform median is not-to-exceed a 2.2 MPN/100 mL and not-to-exceed 23 MPN/100 mL in any one sample in any 30-day period. None are to exceed 240 MPN /100 mL.

³² In direct filtration, the secondary effluent is treated with coagulants, flocculated, and filtered (which avoids the sedimentation step).

³³ The chlorine concentration after 5 minutes of exposure of initial chlorine dose in treated effluent.

³⁴ The product of the residual chlorine concentration (mg/L) times the modal contact time in minutes. In the Pomona instance, the modal contact time in the chlorine contact chamber was 98 minutes.

tertiary treatment using sand filters) in a manner similar to coliforms. The major exception is the observed greater chlorine-resistance of viruses, relative to coliforms, particularly when the chlorine species is chloramine, such as is the case in non-nitrified tertiary effluents. Thus, using coliforms as indicators of virus removal by disinfection has been questioned. In practice, this may not pose a serious problem because, although the rate of disinfection may be greater for coliforms than for viruses, the initial numbers of coliforms are orders of magnitude greater than of viruses; therefore, the time required to reduce coliforms to low numbers should generally be adequate for the reduction of *in situ* virus numbers to low risk levels.

An example of the enteric virus concentration that might be expected in tertiary effluent that meets a total coliform level of ≤ 2.2 MPN/100 mL can be gleaned from the Pomona study. In this instance, the concentration of seeded poliovirus (pfu/100 gallons) in the effluent meeting the treatment and quality requirements specified in the 1978 Wastewater Reclamation Criteria verses the coliform concentration was plotted. The regression analysis resulted in the following equation:

$$Y = 1.75 + 0.43X$$

where Y = virus pfu/100 gallons and X = total coliform concentration per 100 mL. Using this expression, the level of virus in the effluent at a total coliform level of 2 MPN/ 100 mL would be estimated to be 0.00069 PFU per100 mL.

Many of the parasites of importance are present in encysted stages and, as such, can be quite resistant to chemical disinfection, but their numbers in tertiary effluents that meet the CDPH Water Recycling Criteria are normally very low. As an example, data from the Monterey Regional Water Pollution Control Agency (Crook and Jaques, 2005) showing the reduction of *Giardia* and *Cryptosporidium* cysts/oocysts as the wastewater is treated to the specifications³⁵ for disinfected tertiary recycled water are summarized in Table 4.5. Data for the plant effluent for 5 additional years shows the same level in parasite cyst removal. The viability of the cysts recovered is unknown.

Table 4.5 Range of Microbe Concentration in Treatment Effluent

Microorganism	Effluent Treatment Stage		
	Raw	Secondary	Disinfected Tertiary
Fecal Coliform/100 mL	$7 \times 10^6 - 3 \times 10^7$	$2 \times 10^5 - 8 \times 10^5$	<2
<i>Giardia</i> Cysts/L	$2 \times 10^3 - 2 \times 10^4$	$4 \times 10^{-1} - 1.2 \times 10^1$	ND - 3×10^{-1}
<i>Cryptosporidium</i> Oocysts/L	ND* - 2×10^2	ND - 1.8	ND - 4×10^{-1}

*All final tertiary effluents disinfected with chlorine.

ND= Non-detect.

Source: Crook and Jaques (2005).

³⁵ In reporting the results, the coliform data were reported as fecal coliforms and not total coliforms.

In 2004, the Water Environment Research Foundation published a report (Rose et al., 2004) on the presence of microbial indicators and selected pathogen in water reclamation plant effluents. Data were collected from six tertiary wastewater reclamation plants located in various areas of the United States. Over 3 years, there were 34 sampling events, averaging about five from each of the six plants. During each period, samples were collected from the untreated influent, secondary effluent, filtered secondary, and disinfected final product. The samples were assayed for coliforms, clostridium, coliphage, enteric viruses, and viable *Cryptosporidium* oocysts. Unfortunately, there was little, if any, data on plant operation at the time the samples were collected. A summary of the results of the coliform, enteric virus, and viable *Cryptosporidium* assays are shown in Table 4.6. The data are reported as per 100 mL so as to put the relative concentrations in better perspective.

Table 4.6 Overall Geometric Average Concentration of Microorganisms from the Six Treatment Plants

Treatment	Total Coliform (MPN/100 mL)	Fecal Coliform (MPN/100 mL)	Enteric Virus (pfu/100 mL*)	<i>Cryptosporidium</i> Viable Oocysts (MPN/100 mL*)
Untreated	34,000,000	3,500,000	4.0	0.618
Filtered Secondary	3,122	816	0.005	0.009
Disinfected Tertiary	3	1.2	0.0005	0.0004

*Based on values from 100 L (26 gal) samples. Source: Rose et al. (2004).

It can be seen that, on average, the treatment processes produced a significant reduction in coliforms, viruses, and *Cryptosporidium* oocysts. The virus concentrations observed were very similar to those predicted by the Pomona study to be present in tertiary effluents meeting a total coliform level of $\leq 2.2/100$ mL.

A snapshot of selected data from samples positive for enteric virus or viable *Cryptosporidium* cysts along with associated indicator data is shown in Table 4.7. In three instances, enteric viruses were isolated from samples that had 2 or less total coliforms MPN per 100 mL. All the other virus isolations (67 percent) were from samples that had greater than 2 coliforms/100 mL. In the case of the fecal coliform data, there were five instances (55 percent) where none were detected in samples containing viruses. Only two of the 12 samples were positive for enterococci (data not shown).

It appears that, on average, the treatment processes produced a significant reduction in both coliform and in viruses and *Cryptosporidium*. There was one exception where the indicator levels were greater than the 2,000 MPN per 100 mL range but, in this instance, neither enteric virus nor viable *Cryptosporidium* cysts were detected. The enteric viruses and *Cryptosporidium* levels, while present, were at a very low dose level.

There were 12 instances (39 percent) in which the total coliform in the disinfected effluent was greater than 2 MPN/100 mL. Twenty four percent (nine samples) of the 31 filters and disinfected effluent contained enteric viruses ranging from 0.3 to 14 pfu per 100 L or 26 gallons averaging 1.9 pfu/100 L in concentration. Viable *Cryptosporidium* oocysts concentrations were

of the same order as the viruses. A snapshot of selected data from these samples, along with indicator data, is listed in Table 4.7. In three instances, enteric viruses were isolated from samples that had 2 or less total coliforms MPN/100 mL. All the other virus isolations (67 percent) were from samples that had greater than 2 total coliform MPN/100 mL. In the case of fecal coliform data, there were eight instances where none were detected in samples containing viruses and one of these samples also contained detectable viable *Cryptosporidium*.

Table 4.7 Excerpted from WERF Data: Final Effluent Samples From Which Enteric Viruses and Viable *Cryptosporidium* Oocysts Were Isolated^a

Plant	Total Coliform MPN/100 mL	Fecal Coliform MPN/100 mL	Enteric Virus PFU/100 mL	Viable <i>Cryptosporidium</i> MPN/100 mL
A2	3	ND*	0.0015	0.0003
A4	13	ND*	0.00030	ND**
A5	ND*	ND*	0.00080	ND**
B5	ND*	ND*	ND**	0.023
C4	10	ND*	0.00034	ND**
D1	ND*	ND*	ND**	0.0073
D3	ND*	ND*	ND**	0.018
D7	18	5	0.00030	ND**
F3	ND*	ND*	0.00032	ND**
F4	ND*	ND*	0.0003	0.0025
F5	3	ND*	0.00037	0.026
F6	31	ND*	0.00029	ND**

*Sample Less than 2 coliforms/100 mL. **ND=non-detect in 100 L. ^aRose et al. (2004).

A testimony to the effectiveness of the CDPH requirements was presented in a publication (Yanko, 1993) describing 10 years of virus monitoring results collected by the Los Angeles County Sanitary Districts. The following is an abstract from that report:

“Six tertiary treatment water reclamation plants were monitored monthly for enteric viruses for 10 years. Secondary treatment removed 99.8 percent of the detectable viruses. The virus concentrator and assay system detected low levels of native viruses in 74 out of 75 unchlorinated secondary effluent samples. Only 1 of 590 final effluent samples averaging 1,040 L (275 gal) was positive for enteric viruses. These results suggest that the California treatment-based water reclamation standards assure reliable production of essentially virus risk-free effluents” (Yanko, 1993).

Membrane Filtration

The use of membranes (as one of the multiple barriers) in lieu of mixed media filters raises the issue of the utility of coliforms as a monitoring measure. The concern is that filter porosity may be such that coliforms are excluded while the much smaller viruses might pass through. In pilot studies, membranes including microfiltration, ultrafiltration, and reverse osmosis are shown to be effective in reducing viruses in oxidized effluents by as much as 6 logs (Olivieri et al., 1999).

Coliform indicator bacteria will be useful in monitoring for membrane failure, but at this point in time there is no established practical biometric model to monitor for small concentrations of animal viruses. *In situ* coliphage might be a candidate to investigate.

UV Disinfection

There is an increasing interest in ultraviolet (UV) disinfection as an alternative to chlorine. In this instance, the use of coliforms as indicators of process effectiveness has come into question. The coliforms are more sensitive to UV 254 nm than are the *Cryptosporidium* and viruses in that order. These differences are shown in Table 4.8, where coliforms are represented by *E. coli*. The 5-log reduction level was selected as this is the level of virus reduction often required by regulators.

Table 4.8 Comparison of UV Dose Required for a 5-Log Reduction

Microorganism	UV Dose (mJ/cm ²)
<i>E. coli</i>	10
<i>Cryptosporidium</i>	25
Poliovirus	35
MS2 coliphage	100

Extracted from data presented in U.S. EPA (2006).
mJ/cm² = Millijoules per square centimeter.

In the case of UV, the relative difference in the dose response between total coliforms and viruses is substantially greater than that observed when exposed to chloramines, such as is the case in most tertiary effluents. As stated earlier, in this latter instance, the use of high chlorine CTs (doses) to reduce the coliform concentration to the 2.2 MPN level creates a disinfection umbrella due to the low initial concentration of cysts and viruses. In the case of UV disinfection, the umbrella is not so evident. The operation of the UV process must be carefully designed and monitored to ensure that the required UV dose (mJ/cm²) is consistently delivered. In practice, the total coliform requirement of 2.2 MPN/100 mL is frequently difficult to meet because of “tailing” in which the coliforms are shielded from the UV by particles in the 7+ μm range (Domènec et al., 2001). In this case, the total coliform measure indicates that even if the proper UV dose is being delivered, the disinfection efficacy can be in question. It also points to the importance of effective filtration prior to disinfection.

Emerging Indicator Methods: Molecular biologic methods for the identification and enumeration of microorganisms are being actively pursued by the scientific community. These methods hold the promise of rapid, “real time” identification of specific pathogens or indicator organisms present in water and wastewater. The application of the qPCR technique, particularly to recreational waters, is being actively pursued as a potential means to rapidly identify and enumerate indicator bacteria. The routine application of these methods in monitoring recycled water has yet to be shown as a viable alternative. An important issue is matrix interference such

as that caused by humic substances,³⁶ which impacts the real-time advantage, since additional time is required to remove interfering materials from the sample and yet preserve the nucleic acid. The method is based on the identification of microbial nucleic acid sequences, and the enumeration is based on the rate at which the target nucleic acid is amplified (copied). The amplification rate is proportional to the initial concentration of DNA and reported as “copy time.” There are central questions as to how this molecular copy time relates to actual microbe count,³⁷ as well as the question as to the viability of the microbes from which the nucleic acid was extracted.

Panel Finding: At this point in time, there is no practical and time-proven alternative to the coliform standard. The search for the ideal indicator of the sanitary quality of all types of water has been ongoing for more than 50 years with limited success. Culture methods for the detection of members of the coliform group have measurably improved in sensitivity, ease of application, and time required to obtain results. The regulatory agencies should keep abreast of, and carefully evaluate, developments in this area.

References for Question No. 8

- Engineering Science, Inc. (1987). Monterey Water Reclamation Study for Agriculture - Final Report. Berkeley, CA.
- California Department of Public Health (1933). Special Bulletin #39: Regulations on Use of Sewage for Irrigation Purposes.
- California State Board of Health Bulletin (1906).
- Crook, J., and R.C. Jaques (2005). Monterey County Recycling Project: A Case Study. In: *Water Conservation, Reuse, and Recycling*, Proceedings of the Iranian-American Workshop, The National Academy Press pp187 -198.
- Domènec J., C .Lam, and P. Pitt (2001). “Particle Effects on Ultraviolet Disinfection of Coliform Bacteria in Recycled Water.” *Water Environment Research* Vol. 73, (2): 233-236.
- Oberbauer, Barbara A. (1992). “*Theodor Escherich - Leben und Werk*”. Paul-Ehrlich-Gesellschaft für Chemotherapie. Futuramed-Verlag, 11 (3).
- Olivieri, A., D. Eisenberg, J. Soller, J. Eisenberg, R. Cooper, G. Tchobanoglous, R. Trussell and P. Gagliardo (1999). "Estimation of pathogen removal in an advanced water treatment facility using Monte Carlo simulation." *Water Sci. Technol.*, 40(4-5): 223-234.
- Rose, J.B., Nowlin, H., Farrah, S.R., Harwood, V., Levine, A., Lukasik, J., Menendez, P. &Scott, T.M. (2004). Reduction of pathogens, indicator bacteria, and alternative indicators by wastewater treatment and reclamation processes. Water Environment Research Foundation Report 00-PUM2T.

³⁶ WERF Research Publication: “A Paradigm Shift: WERF’s Waterborne Pathogens Research Program Findings and Applications.” WERF Research and Tools Web Site: <http://www.werf.org/i/a/k/PathogensHumanHealth.aspx> (last accessed April 19, 2012).

³⁷ For example, the EPA has determined that a 475 “cell equivalent” by PCR corresponds to 35 Enterococci colony forming units (cfu)/100 mL.

Sanitation Districts of Los Angeles County (1977). “Pomona virus study: final report for The, California. State Water Resources Control Board and United States. Environmental Protection Agency.” 230pp.

State of California (1975). *Wastewater Reclamation Criteria*. California Administrative Code, Title 22, Division 4, California Department of Health Services, Sanitary Engineering Section, Berkeley, California.

State of California (2000). *Water Recycling Criteria*. California Code of Regulations, Title 22, Division 4, Chapter 3. California Department of Health Services, Sacramento, California.

U.S. EPA (2006). “Ultraviolet Disinfection Guidance Manual for The Final Long Term 2 Enhanced Surface Water Treatment Rule” EPA 815-R-06-007 388pp.

Yanko, W.A (1993). “Analysis of Ten Years of Virus Data from Los Angeles County Treatment Plants Meeting California Wastewater Treatment Criteria.” *Water Environment Research* (66)3, 221 -226.

4.6 Question No. 9: Do Crops Take Up Pathogenic Viruses? If Yes, Is this Route of Exposure a Public Health Concern for Agriculture Irrigation with Recycled Water?

Most of the recent large outbreaks associated with bacterial enteric pathogen (e.g., enterohemorrhagic *E. coli*, *S. enterica*) contamination of fresh produce (e.g., leafy greens, tomatoes, peppers, sprouts, melons) have occurred as a result of pre-harvest contamination (Mandrell, 2011), although the exact source of contamination is often unknown or unclear. Similarly, pre-harvest contamination of fresh produce by viruses or protozoa has been reported. Hepatitis A virus (MMWR, 2003; Niu et al., 1992; Wheeler et al., 2005) and norovirus (CSPI, 2009) are the most common viruses associated with outbreaks linked to produce. The large number of produce-related norovirus outbreaks (CSPI, 2009; Ethelberg et al., 2010), the obvious presence of norovirus in marine waters or watersheds (Noda et al., 2008; Tian et al., 2007), the ability of human norovirus to replicate in cattle and pigs (Koopmans, 2008), and the fitness and incidence of norovirus on leafy vegetables (Baert et al., 2011; Leon-Felix et al., 2010; Mara and Sleigh, 2010; Wei et al., 2010) emphasize the need for more research on norovirus in the produce production environment. A recent cluster of at least 11 outbreaks in Denmark and Norway associated with norovirus on lettuce suspected of being contaminated in fields in France (Ethelberg et al., 2010) and incidence of norovirus on leafy greens in Canada sourced from the United States (Baert et al., 2011) underscores why pre-harvest produce sources of norovirus should be considered more seriously. Previous reviews have noted the role of protozoa associated with foodborne illness (*Cryptosporidium*, *Cyclospora*, and *Giardia*) and selected outbreaks linked to fresh produce likely resulting from pre-harvest contamination or poor quality water (Duffy and Moriarty, 2003; Rose and Slifko, 1999). Thus, the microorganisms noted above are a priority for determining the effectiveness in removing and/or killing them during the recycled water treatment process.

The lack of any identifiable foodborne illnesses linked to California produce irrigated with recycled water implies that pathogens usually are killed or at doses inadequate for infection. The “Infectious Dose” (ID) is typically defined as the number of organisms that cause disease in a

host. Previous studies indicate that enteric bacterial and viral human pathogens can infect, colonize, and cause illness in humans, but at a wide range of bacterial cells or viral particles consumed. The ID of a particular pathogen for humans will depend upon many factors; for example, the virulence of the pathogen strain in food or water consumed by the host, host immunity and specificity (genetics), and competing and/or cooperating microflora. Thus, the pathogen ID in a specific contamination event may range widely relative to these factors. Several studies have reported the IDs for some important enteric pathogens based on volunteer studies and also available contaminated food that could be evaluated after sporadic illnesses and outbreaks associated with the food. A summary of some of these studies is provided in Table 4.9 to give a context for evaluating the risks of contaminated water.

Table 4.9 Summary of Data on Pathogen Infectious Doses (IDs) for Humans

Pathogen ^a	Range of IDs Causing Illness ^b	References
<i>S. enterica</i> (volunteers)	2 x 10 ⁹ to 1 x 10 ¹⁰ in water	Blaser and Newman, 1982
<i>S. enterica</i> (volunteers)	1.3 x 10 ⁵ to 1 x 10 ¹⁰ in eggnog	Blaser and Newman, 1982
<i>S. enterica</i> (volunteers)	1 x 10 ⁵ to 1.3 x 10 ⁹ in milk	Blaser and Newman, 1982
<i>S. enterica</i> (11 outbreaks; water and food) ^c	(1) 17 (2) 60-90 (3) 44-200 (4) 60-230 (5) 100-250 (6) 100-500 (7) 1.1 x 10 ⁴ (8) 1.5 x 10 ⁴ – 6 x 10 ⁴ (9) 1.5 x 10 ⁵ (10) 1 x 10 ⁶ – 2 x 10 ⁶ (11) 1 x 10 ¹¹	Blaser and Newman, 1982
<i>S. enterica</i> (cheddar cheese)	0.7 to 6.1	D'Aoust, 1985
<i>E. coli</i> O157:H7 (deer jerky)	7.5 x 10 ² to 4.7 x 10 ⁴	Keene et al., 1997
<i>E. coli</i> O157:H7 (hamburger)	<700	Tuttle et al., 1999
<i>E. coli</i> O157:H7 (salad/seafood sauce)	31-35	Teunis et al., 2004
<i>E. coli</i> O157:H7 (beef, liver), two studies	(1) 2-9 (2) 108-216	Hara-Kudo and Takatori, 2011
<i>Shigella flexneri</i>	<140	Kothary and Babu, 2001
<i>Cryptosporidium</i> (volunteers), three separate studies	(1) 9 (2) 87 (3) 1042	Teunis et al., 2002
Norovirus (volunteers) ^d	1 to 1000	Teunis et al., 2008
Norovirus (volunteers) ^e	6.5 x 10 ⁸	Seitz et al., 2011

- a) Different *S. enterica* serovars are represented for both volunteer studies and outbreaks.
- b) Ranges of IDs are listed as the most probable number of microorganism cells or viral particles present.
- c) Ranges of IDs are listed for the 11 outbreaks in order of lowest to highest IDs.
- d) The wide range for the ID shown relates to secretor status (only secretor-positive humans are susceptible) and reflects the fact that virus could be aggregated (high ID number) or disaggregated (low ID number).
- e) Volunteers were challenged with 6.5 x 10⁸ "genomic equivalent copies" of NV 8FIIb in groundwater stored for 0 to 61 days in groundwater in the dark at room temperature. The "number-of-infected/number-of-challenged" values after 0, 7, 14, 21, 27, and 61 days stored were 2/2, 2/2, 2/2, 1/4, 1/1, and 2/2, respectively, indicating at least some virus in a very large dose can remain infective for at least 61 days and produce clinical symptoms.

The microorganisms listed in Table 4.9 are relevant to re-evaluation of the safety of recycled water because of their association with multiple recent outbreaks linked to fresh produce (Seitz et al., 2011) and/or large outbreaks and other issues related to municipal wastewater treatment (MacKenzie et al., 1995). Norovirus and Shigella species are relevant, especially, because they are strictly human pathogens, always or often in municipal sewage influents. Nevertheless, it should be noted that, after more than 40 years of use, no outbreaks have been linked to irrigation by recycled water in California (Parsons et al., 2010).

Enteric bacteria are capable of attaching and surviving on plants. The general biology, ecology, and fitness characteristics of human enteric pathogens on plants have been reviewed (Brandl, 2006). Laboratory studies indicate that *E. coli* O157:H7 and *Salmonella* applied to a variety of plant roots, leaves, and seeds can attach tenaciously (resisting sanitization – for example, washing and/or washing with disinfectants) and survive, but also in some instances grow when conditions are ideal for a pathogen (warm temperature, high humidity, adequate nutrients) and that complex interactions may occur on plants in the field (Brandl, 2006). Field studies with generic *E. coli*, attenuated strains of *E. coli* O157:H7, and other pathogen surrogates on plants confirm that rapid die-off can occur, but also that some cells can survive for weeks or, in some cases, months (Islam et al., 2004; Moyne et al., 2011; Tomas-Callejas et al., 2011). Of course, the survival characteristics of confirmed pathogenic strains (e.g., serovars/strains associated with illness from *E. coli* O157:H7, *E. coli* O145, and other Shiga toxin positive *E. coli*) under field conditions cannot be determined safely, so there are gaps in our knowledge of how small numbers of pathogen cells in recycled water or on irrigated produce survive under varying field conditions (UV, temperature, moisture, wind, fertilizers, pesticides, etc.).

A somewhat controversial issue relevant to irrigation with recycled wastewater is whether pathogen cells exposed to plants can internalize through different routes of entry on roots, shoots, or flowers. There have been numerous laboratory studies reporting that bacterial pathogen internalization occurs in the lab (Dong et al., 2003; Doyle and Erickson, 2008; Franz et al., 2007; Guo et al., 2001; Kroupitski et al., 2009; Schikora et al., 2008; Solomon et al., 2002; Warriner et al., 2003), although usually at minimal levels, even with a high inoculum of cells (Erickson et al., 2010; Sharma et al., 2009). A comprehensive review of these and other studies of internalization of bacterial foodborne pathogens in plants notes that high inocula of cells are often required to obtain internalization, internalization into roots from soil is minimal, and cut plant surfaces are the most vulnerable to internalization (Erickson, 2012). Indeed, concerns in the 1950s about poliovirus led to studies reporting internalization of the virus through plant roots (Murphy et al., 1958), and evidence of survival of poliovirus 1 for weeks in inoculated sewage wastes and the contamination, presumably through roots, of lettuces and radishes planted in the inoculated fields (Tierney et al., 1977). A similar study with tomatoes reported limited penetration of the roots by a high inoculum of Poliovirus I, but no detection of virus in leaves or fruit (Oron et al., 1995). A large outbreak of Hepatitis A in green onions led to a lab study reporting the internalization of virus through roots in hydroponically grown onions (Chancellor et al., 2006). Murine norovirus, as a surrogate for human norovirus, has been reported to internalize in lettuce, although only with unnaturally high inoculums (Wei et al., 2011). However, similar experiments with human norovirus determined no evidence of internalization (Urbanucci et al., 2009). It remains unclear whether these laboratory results relate to potential internalization in the field, but the generally small numbers of cells that internalize even in the laboratory with high inoculums of cells

suggest that attachment of cells to surfaces of plants is the major vehicle of contamination and may result from irrigation with contaminated water (Sharma et al., 2009; Erickson, 2012).

Panel Finding: The potential presence of human pathogens in recycled water and their uptake (internalization) into plant tissue via the root system, leaf stoma, etc. were raised as potential concerns. There is evidence that internalization may occur under laboratory conditions with exposure to a high concentration of pathogens. The most realistic scenario is the attachment of microbial pathogens to plant surfaces in such a way that processing sanitization or other intervention is less effective. This latter scenario is the probable mechanism of contamination associated with recent outbreaks (e.g., see more detailed discussion above and in Baert et al., 2011), none of which were associated with the use of recycled water for irrigation.

There are no definitive links to any outbreaks or sporadic illness associated with irrigation of California produce with recycled water, nor with recycled water used extensively in Florida for irrigation. Monterey County recycled water used for irrigation of leafy greens and other produce (Parsons et al., 2010) is a local example of the reuse of treated wastewater for an extended period without any known link to human illness.

References for Question No. 9

- Baert, L., K. Mattison, F. Loisy-Hamon, J. Harlow, A. Martyres, B. Lebeau, A. Stals, E. Van Coillie, L. Herman, and M. Uyttendaele (2011). "Review: norovirus prevalence in Belgian, Canadian and French fresh produce: a threat to human health?" *Int J Food Microbiol.*, 151:261-269.
- Blaser, MJ, and Newman LS (1982). A review of human salmonellosis: I. Infective dose. *Rev Infect Dis.* 4:1096-1106.
- Brandl, MT (2006). Fitness of human enteric pathogens on plants and implications for food safety. *Annu Rev Phytopathol.* 44:367-392.
- Chancellor, DD, Tyagi S, Bazaco MC, Bacvinskas S, Chancellor MB, Dato VM, and de Miguel F (2006). Green onions: potential mechanism for hepatitis A contamination. *J Food Prot.* 69:1468-1472.
- CSPI (2009). Outbreak Alert! Analyzing foodborne outbreaks, 1998-2007. Washington, DC. <http://cspinet.org/new/pdf/outbreakalertreport09.pdf>.
- D'Aoust, JY (1985). Infective dose of *Salmonella typhimurium* in cheddar cheese. *Am J Epidemiol.* 122:717-720.
- Dong, Y, Iniguez AL, Triplett EW, and Ahmer BMM (2003). Kinetics and strain specificity of rhizosphere and endophytic colonization by enteric bacteria on seedlings of *Medicago sativa* and *Medicago truncatula*. *Appl Environ Microbiol.* 69:1783-1790.
- Doyle, MP, and Erickson MC (2008). Summer meeting 2007 - the problems with fresh produce: an overview. *J Appl Microbiol.* 105:317-330.
- Duffy, G, and Moriarty EM (2003). *Cryptosporidium* and its potential as a food-borne pathogen. *Anim Health Res Rev.* 4:95-107.
- Erickson, MC, Webb CC, Diaz-Perez JC, Phatak SC, Silvoy JJ, Davey L, Payton AS, Liao J, Ma

- L, and Doyle MP (2010). Infrequent internalization of *Escherichia coli* O157:H7 into field-grown leafy greens. *J Food Prot.* 73:500-506.
- Erickson, MC (2012). Internalization of fresh produce by foodborne pathogens. *Annu. Rev Food Sci. Technol.* 3:283-310.
- Ethelberg, S, Lisby M, Böttiger B, Schultz AC, Villif A, Jensen T, Olsen KE, Scheutz F, Kjelsø C, and Müller L (2010). Outbreaks of gastroenteritis linked to lettuce, Denmark, January 2010. *Eurosurveillance.* 15:pii=19484.
- Franz E, Visser AA, Van Diepeningen AD, Klerks MM, Termorshuizen AJ, and van Bruggen AH (2007). Quantification of contamination of lettuce by GFP-expressing *Escherichia coli* O157:H7 and *Salmonella enterica* serovar Typhimurium. *Food Microbiol.* 24:106-112.
- Guo, X, Chen J, Brackett RE, and Beuchat LR (2001). Survival of salmonellae on and in tomato plants from the time of inoculation at flowering and early stages of fruit development through fruit ripening. *Appl Environ Microbiol.* 67:4760-4764.
- Hara-Kudo, Y, and Takatori K (2011). Contamination level and ingestion dose of foodborne pathogens associated with infections. *Epidemiol Infect.* 139:1505-1510.
- Islam, M, Doyle MP, Phatak SC, Millner P, and Jiang X (2004). Persistence of enterohemorrhagic *Escherichia coli* O157:H7 in soil and on leaf lettuce and parsley grown in fields treated with contaminated manure composts or irrigation water. *J Food Prot.* 67:1365-1370.
- Keene, WE, Sazie E, Kok J, Rice DH, Hancock DD, Balan VK, Zhao T, and Doyle MP (1997). An outbreak of *Escherichia coli* O157:H7 infections traced to jerky made from deer meat. *JAMA.* 277:1229-1231.
- Koopmans, M. (2008). Progress in understanding norovirus epidemiology. *Curr Opin Infect Dis.* 21:544-552.
- Kothary, MH, and Babu UMAS (2001). Infective dose of foodborne pathogens in volunteers: a review. *Journal of Food Safety.* 21:49-68.
- Kroupitski, Y, Golberg D, Belausov E, Pinto R, Swartzberg D, Granot D, and Sela S (2009). Internalization of *Salmonella enterica* in leaves is induced by light and involves chemotaxis and penetration through open stomata. *Appl Environ Microbiol.* 75:6076-6086.
- Leon-Felix, J, Martinez-Bustillos RA, Baez-Sanudo M, Peraza-Garay F, and Chaidez C (2010). Norovirus contamination of bell pepper from handling during harvesting and packing. *Food and Environmental Virology.* 2:1-7.
- MacKenzie, WR, Schell WL, Blair KA, Addiss DG, Peterson DE, Hoxie NJ, Kazmierczak JJ, and Davis JP (1995). Massive outbreak of waterborne cryptosporidium infection in Milwaukee, Wisconsin: recurrence of illness and risk of secondary transmission. *Clin Infect Dis.* 21:57-62.
- Mandrell, RE (2011). Tracing pathogens in fruit and vegetable production chains, p. 548-595. In Brul S, Fratamico PM, and McMeekin T (ed.), *Tracing Pathogens in the Food Chain.* Woodhead Publishing Ltd., Cambridge, UK.

- Mara, D, and Sleigh A (2010). Estimation of norovirus infection risks to consumers of wastewater-irrigated food crops eaten raw. *J Water Health*. 8:39-43.
- MMWR (2003). Hepatitis A outbreak associated with green onions at a restaurant--Monaca, Pennsylvania, 2003. *MMWR Morb Mortal Wkly Rep*. 52:1155-1157.
- Moyne, AL, Sudarshana MR, Blessington T, Koike ST, Cahn MD, and Harris LJ (2011). Fate of *Escherichia coli* O157:H7 in field-inoculated lettuce. *Food Microbiol*. 28:1417-1425.
- Murphy, WH, Jr., Eylar OR, Schmidt EL, and Syverton JT (1958). Absorption and translocation of mammalian viruses by plants. I. Survival of mouse encephalomyelitis and poliomyelitis viruses in soil and plant root environment. *Virology*. 6:612-622.
- Niu MT, Polish LB, Robertson BH, Khanna BK, Woodruff BA, Shapiro CN, Miller MA, Smith JD, Gedrose JK, Alter MJ, and et al. (1992). Multistate outbreak of hepatitis A associated with frozen strawberries. *J Infect Dis*. 166:518-524.
- Noda M, Fukuda S, and Nishio O (2008). Statistical analysis of attack rate in norovirus foodborne outbreaks. *Int J Food Microbiol*. 122:216-220.
- Oron G, Goemans M, Manor Y, and Feyen J (1995). Poliovirus distribution in the soil-plant system under reuse of secondary wastewater. *Water Research*. 29:1069-1078.
- Parsons LR, Sheikh B, Holden R, and York DW (2010). Reclaimed water as an alternative water source for crop irrigation. *HortScience*. 45:1626-1629.
- Rose JB, and Slifko TR (1999). Giardia, Cryptosporidium, and Cyclospora and their impact on foods: a review. *J Food Prot*. 62:1059-1070.
- Schikora A, Carreri A, Charpentier E, and Hirt H (2008). The dark side of the salad: *Salmonella typhimurium* overcomes the innate immune response of *Arabidopsis thaliana* and shows an endopathogenic lifestyle. *PLoS ONE*. 3:e2279.
- Seitz SR, Leon JS, Schwab KJ, Lyon GM, Dowd M, McDaniels M, Abdulhafid G, Fernandez ML, Lindesmith LC, Baric RS, and Moe CL (2011). Norovirus infectivity in humans and persistence in water. *Appl Environ Microbiol*. 77:6884-6888.
- Sharma M, Ingram DT, Patel JR, Millner PD, Wang X, Hull AE, and Donnenberg MS (2009). A novel approach to investigate the uptake and internalization of *Escherichia coli* O157:H7 in spinach cultivated in soil and hydroponic medium. *J Food Prot*. 72:1513-1520.
- Solomon EB, Yaron S, and Matthews KR (2002). Transmission of *Escherichia coli* O157:H7 from contaminated manure and irrigation water to lettuce plant tissue and its subsequent internalization. *Appl Environ Microbiol*. 68:397-400.
- Teunis P, Takumi K, and Shinagawa K (2004). Dose response for infection by *Escherichia coli* O157:H7 from outbreak data. *Risk Anal*. 24:401-407.
- Teunis PF, Chappell CL, and Okhuysen PC (2002). Cryptosporidium dose response studies: variation between isolates. *Risk Anal*. 22:175-183.
- Teunis PF, Moe CL, Liu P, Miller SE, Lindesmith L, Baric RS, Le Pendu J, and Calderon RL (2008). Norwalk virus: how infectious is it? *J Med Virol*. 80:1468-1476.
- Tian P, Engelbrektsen AL, Jiang X, Zhong W, and Mandrell RE (2007). Norovirus recognizes histo-blood group antigens on gastrointestinal cells of clams, mussels, and oysters: a

- possible mechanism of bioaccumulation. *J Food Prot.* 70:2140-2147.
- Tierney JT, Sullivan R, and Larkin EP (1977). Persistence of poliovirus 1 in soil and on vegetables grown in soil previously flooded with inoculated sewage sludge or effluent. *Appl Environ Microbiol.* 33:109-113.
- Tomas-Callejas A, Lopez-Velasco G, Camacho AB, Artes F, Artes-Hernandez F, and Suslow TV (2011). Survival and distribution of *Escherichia coli* on diverse fresh-cut baby leafy greens under preharvest through postharvest conditions. *Int J Food Microbiol.* 151:216-222.
- Tuttle J, Gomez T, Doyle MP, Wells JG, Zhao T, Tauxe RV, and Griffin PM (1999). Lessons from a large outbreak of *Escherichia coli* O157:H7 infections: insights into the infectious dose and method of widespread contamination of hamburger patties. *Epidemiol Infect.* 122:185-192.
- Urbanucci A, Myrmel M, Berg I, von Bonsdorff CH, and Maunula L (2009). Potential internalisation of caliciviruses in lettuce. *Int J Food Microbiol.* 135:175-178.
- Warriner K, Ibrahim F, Dickinson M, Wright C, and Waites WM (2003). Internalization of human pathogens within growing salad vegetables. *Biotechnol Genet Eng Rev.* 20:117-134.
- Wei J, Jin Y, Sims T, and Kniel KE (2010). Manure- and biosolids-resident murine norovirus 1 attachment to and internalization by Romaine lettuce. *Appl Environ Microbiol.* 76:578-583.
- Wei J, Jin Y, Sims T, and Kniel KE (2011). Internalization of murine norovirus 1 by *Lactuca sativa* during irrigation. *Appl Environ Microbiol.* 77:2508-2512.
- Wheeler C, Vogt TM, Armstrong GL, Vaughan G, Weltman A, Nainan OV, Dato V, Xia G, Waller K, Amon J, Lee TM, Highbaugh-Battle A, Hembree C, Evenson S, Ruta MA, Williams IT, Fiore AE, and Bell BP (2005). An outbreak of hepatitis A associated with green onions. *N Engl J Med.* 353:890-897.

5.0 FUTURE INVESTIGATIONS

The Panel, as part of the review of the Water Recycling Criteria, recommends that CDPH investigate addressing the following two topics to refine and augment current criteria:

5.1 Augment Water Recycling Criteria Turbidity Requirement with Particle Size and Distribution Performance Measure

Currently, the effluent turbidity requirement for most reuse applications included in the Water Recycling Criteria is 2 NTU where effluent (media) filters are used and 0.2 NTU where membranes (microfiltration and and/or ultrafiltration) are used. While the continuous monitoring of turbidity is useful for process control, it is not the most effective measure to assure effective disinfection performance with a variety of agents. The measurement of turbidity, its limitations, and the need to consider particle size and distribution are reviewed below.

Measurement of Turbidity: Turbidity is a measure of the light scattering properties of a solution containing suspended and colloidal particles. Turbidity measurements require a light source (incandescent or light-emitting diode) and a sensor to measure the scattered light. As shown on Figure 5.1, the scattered light sensor is located at 90 degrees to the light source. The measured turbidity increases as the intensity of the scattered light increases. Turbidity is expressed in NTU. The spatial distribution and intensity of the scattered light, also illustrated on Figure 5.1, will depend on the size of the particle relative to the wavelength of the light source. For particles less than one-tenth of the wave length of the incident light, the scattering of light is fairly symmetrical (suspended particle [a] in Figure 5.1) (Tchobanoglous et al., 2003).

Limitations of Turbidity Measurements: As the particle size increases relative to the wave length of the incident light, the light reflected from different parts of the particle create interference patterns that are additive in the forward direction (suspended particles [b] and [c] in Figure 5.1). Also, the intensity of the scattered light varies with the wavelength of the incident light. For example, blue light is scattered more than red light. As a result, the turbidity of a solution of lamp black will essentially be equal to zero. Based on these considerations, turbidity measurements tend to be more sensitive to particles in the size range of the incident light wavelength (0.3 to 0.7 μm for visible light).

Thus, two filtered wastewater samples with nearly identical turbidity values could have very different particle size distributions. A further complication with turbidity measurements is that some particles will essentially adsorb most of the light, and only scatter a minimal amount of the incident light. Also, because of the light scattering characteristics of large particles (suspended particle [c] in Figure 5.1), a few large particles would not be detected in the presence of many smaller particles (Tchobanoglous et al., 2003). As a result, it is impossible to assess disinfection performance based on turbidity values. However, as noted previously, turbidity readings at a given facility can be used for process control.

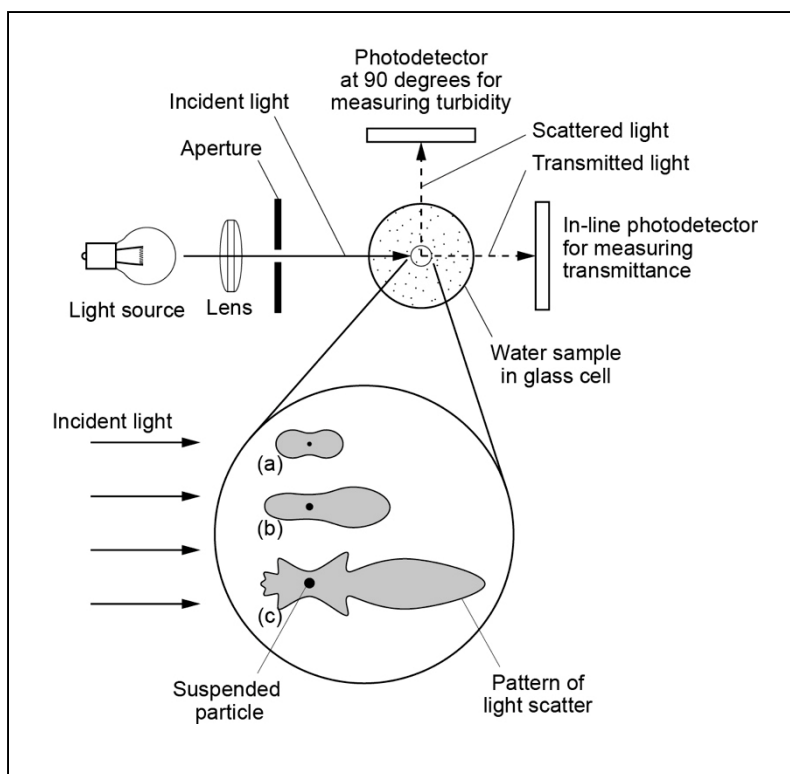

Figure 5.1 Definition sketch for the determination of turbidity and light scattering patterns for various size particles (Tchobanoglous et al., 2003).

Need to Consider Particle Size and Distribution: While CDPH-approved effluent filters (State of California, 2008) will each produce an effluent turbidity of 2 NTU or less, the filtered particle size distribution will be different for each filter due to the physical characteristics of the filtering medium (e.g., woven plastic cloths, stainless steel cloths, compressible filter medium, sand, anthracite, etc.). For example, some filters will pass particles sizes as large as 20 μm . A comparison of two filters from a recent presentation (Figure 5.2) can be used to illustrate the differences that are observed in the field. Clearly, based on the turbidity difference, the particle size distribution in the filter effluent when filtering the same secondary effluent was different for the two filters. Information on particle size and particle size distribution is of importance in assessing the effectiveness of treatment processes (e.g., secondary sedimentation, effluent filtration, and effluent disinfection). Because the effectiveness of chlorine, ozone, and UV disinfection is dependent on particle size, the distribution of effluent particle size should be a consideration for approved filters.

Recommendation: Because turbidity readings do not necessarily correlate with disinfection performance, it is recommended that CDPH undertake a comprehensive study to assess the benefits of incorporating particle size and distribution as a performance measure for filters used for applications covered in the Water Recycling Criteria. Ultimately, it is envisioned that the turbidity requirement would be augmented with a requirement based on particle size distribution.

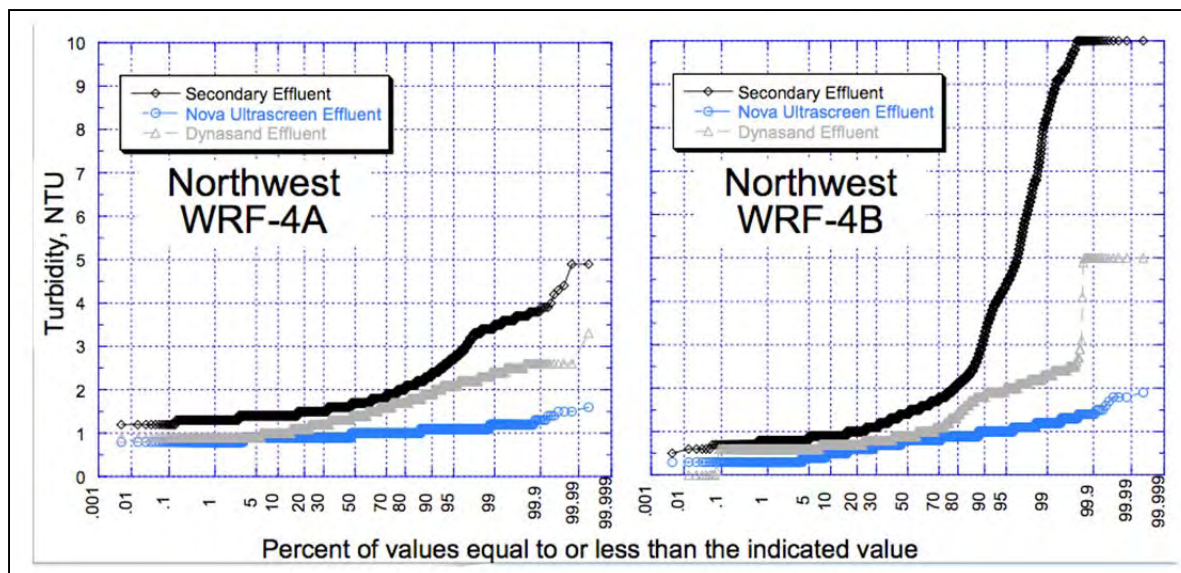
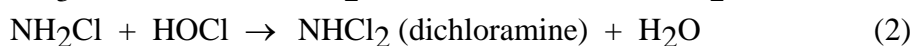
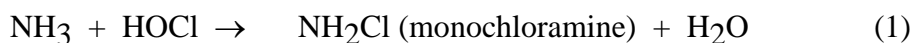

Figure 5.2 Comparison of the performance of two filters based on turbidity (Bourgeois et al., 2010).

5.2 Review of CT Requirement

Use of the CT concept as described in the body of the report evolved out of experimental work conducted as part of the Pomona Virus Study. The findings are contained in the final report published in 1977 (Sanitation Districts of Los Angeles County, 1977). From an analysis of the data contained in that report, it was determined that a CT value (combined chlorine residual times time) of 450 mg-min/L when combined with effluent filtration or other treatments would provide for a 5-log reduction of polio virus. To apply this CT value, it was assumed that the form of chlorine responsible for the observed disinfection performance was combined chlorine. The reason that combined chlorine was used as the basis for the CT relationship is that essentially all of the treatment plants that were in operation at the time in California, as discussed below, were only concerned with meeting the minimum EPA discharge standards for BOD and TSS. Effluent ammonia was not a concern. However, when chlorine is added to a treated effluent containing ammonia, chloramines are formed according to the following reactions.



If enough chlorine is added, the ammonia will be oxidized to nitrogen gas according the following reaction:

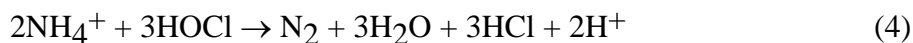

The term *breakpoint chlorination* is used to describe the process whereby enough chlorine is

added to react with all oxidizable substances such that if additional chlorine is added, it will remain as free chlorine. The presence of free chlorine is significant as it has been shown that when free chlorine is present, the rate of disinfection is up to 100 to 200 times more effective than combined chlorine (Crittenden et al., 2012; U.S. EPA, 2003). Because wastewater treatment technology has changed significantly since the late 1970s, and CT values needed to achieve the same 5-log reduction of polio virus would be significantly lower than 450 mg-min/L when using free chlorine, there is considerable interest in revisiting and possibly further defining and/or clarifying the application of the current CT requirement.

Evolution of Wastewater Treatment Technologies: The rationale for revising the current CT requirement based on combined chlorine is based on the fact that the newer wastewater treatment technologies now being implemented achieve complete nitrification. In the late 1970s, the three principal types of wastewater treatment plants were (1) attached growth trickling filters (Figure 5.3[a]), (2) conventional activated sludge (Figure 5.3[b]), and (3) assorted pond or lagoon systems. In general, nitrification (the conversion of ammonia to nitrate) was not practiced, although given the warm summer temperatures experienced in many parts of the state, partial nitrification would almost always occur. Because partial nitrification complicated the addition of chlorine for disinfection, the treatment plants were operated to avoid nitrification.

Since the late 1980s, effluent discharge permits with nitrogen (ammonia primarily) limits have been issued to protect specific water bodies, especially those subject to eutrophication. To meet new ammonia limits, a number of new treatment technologies have been developed. The process shown in Figure 5.3(c) known as the Modified Ludzack Ettinger process was developed to both nitrify and denitrify. The treatment process shown in Figure 5.3 (d) known as the A2/O process is designed to nitrify, denitrify, and remove phosphorus. Because both of these activated sludge processes nitrify, there is an interest in being able to disinfect with free chlorine at a reduced CT value. Any residual ammonia in the effluent would be oxidized and, beyond the breakpoint, disinfection would occur with free chlorine.

Within the past 10 years, an additional process known as the membrane bioreactor (MBR) process has been developed (Figure 5.3[e]). The MBR process utilizes membranes instead of secondary sedimentation facilities to produce a high quality effluent, typically with an effluent turbidity of 0.2 NTU or less. It is important to note that for the MBR process to function properly, it must nitrify completely. Because the effluent is essentially completely nitrified, there is interest in being able to disinfect with free chlorine. The ability to disinfect with free chlorine would be particularly valuable at facilities (e.g., those using MBRs in satellite applications) where sufficient space is not available to build a chlorine contact tank with sufficient time to achieve a CT value of 450 mg-min/L.

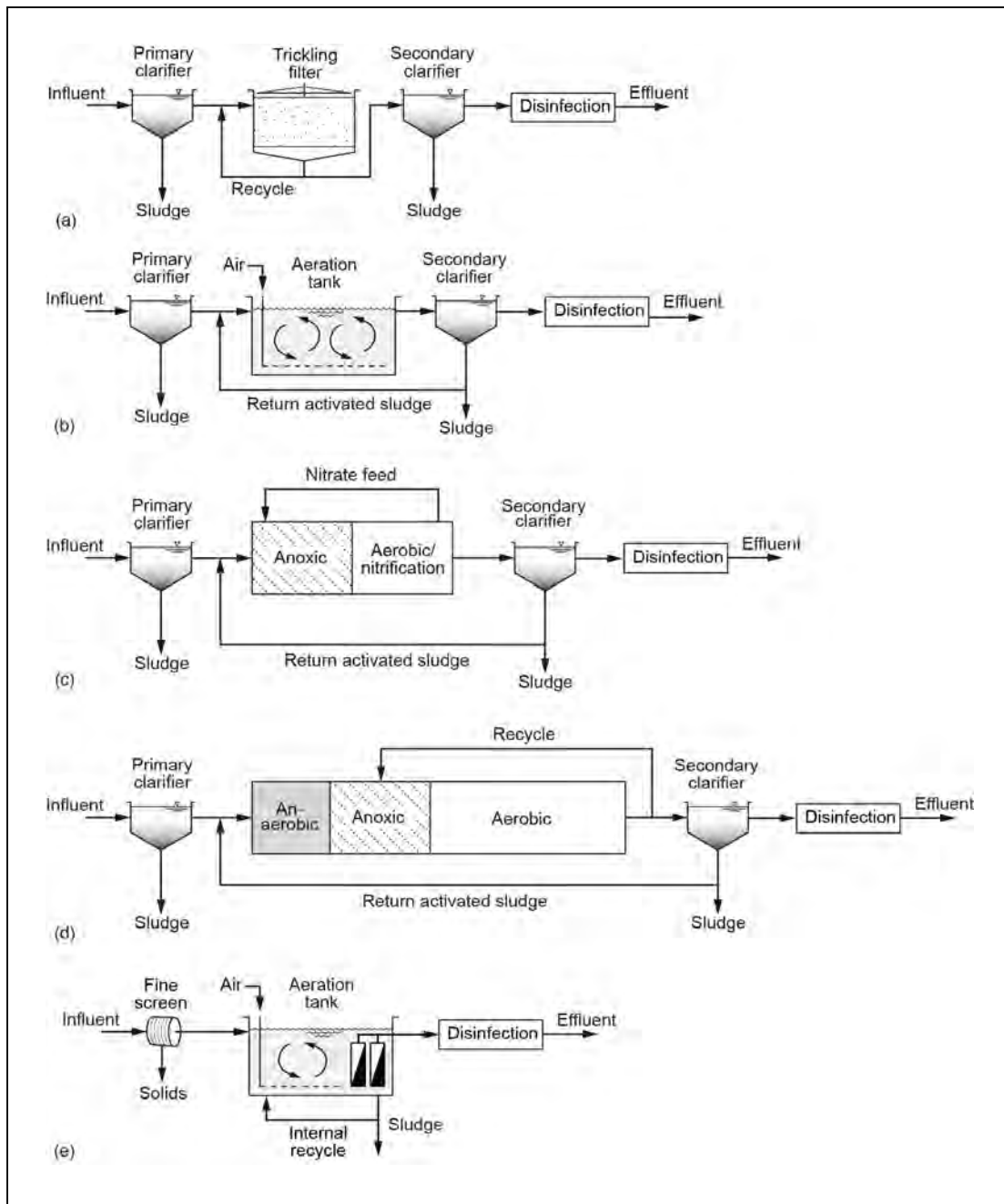

Figure 5.3 Generalized process flow diagrams for typical treatment processes, all of which include chlorine disinfection for pathogen control: (a) trickling filter for TSS and BOD removal; (b) activated sludge for TSS and BOD removal and nitrification; (c) suspended growth biological treatment for TSS, BOD, and nitrogen removal; (d) suspended growth biological treatment for TSS, BOD, nitrogen, and phosphorus removal; and (e) membrane bioreactor for TSS and BOD removal and nitrification.

CT Values Based on Free Chlorine: As noted previously, the current CT value for effluent disinfection, based on combined chlorine, is 450 mg-min/L. By comparison, the CT values published by the U.S. EPA, based on free chlorine, are reported in Table 5.1. As shown in Table 5.1, at 20°C, the required CT value for log-inactivation of viruses is 3 mg-min/L.

Table 5.1 CT Values (min•mg/L) for 4-Log Inactivation of Viruses by Free Chlorine

Inactivation at pH	Temperature (°C)					
	0.5	5	10	15	20	25
6-9	12	8	6	4	3	2
10	90	60	45	30	22	15

Adapted from Appendix B (CT Tables) from U.S. EPA (2003).
 CT values at other temperatures may be determined by interpolation.
 min•mg/L = Milligrams per minute per liter.

Using the Rennecker-Marinas and/or the Collins-Selleck kinetic model (Crittenden et al., 2012) for disinfection with free chlorine, the CT value required to achieve a 5-log inactivation of virus is about 4 mg-min/L. It is anticipated that CT values for nitrified effluent would be on the order of 20 to 30 mg-min/L to take into account the differences in the chemical composition of wastewater as compared to drinking water.

Recommendation: Because the use of free chlorine can offer significant advantages over the use of combined chlorine, especially when coupled with the use of MBRs in satellite applications, it is recommended that CDPH undertake a comprehensive study of the required CT values based on free chlorine for wastewater treatment processes that nitrify completely. Ultimately, it is envisioned that the required CT values would be based on the wastewater treatment technology, process control, and process monitoring instrumentation. As part of developing the scope for this recommended investigation, CDPH should review the 2006 WRRF document entitled, “Pathogen Removal and Inactivation in Reclamation Plants – Study Design” (Darby et al., 2006).

References

Bourgeois, K., N. Fontaine, and K. Marks (2010). "Validation Testing of a High Rate Disk Filter for Water Recycling Applications." Presented at the Pacific Northwest Clean Water Conference, NCWA 2010

Crittenden, J.C., R.R. Trussell, D.W. Hand, K.J. Howe, and G. Tchobanoglous (2012). *Water Treatment: Principles and Design*, 3rd ed., John Wiley & Sons, Inc., New York.

Darby, J., A. Olivieri, C. Tang, and A. Salveson (2006). *Pathogen Removal and Inactivation in Reclamation Plants – Study Design* (WRF-03-001), WateReuse Research Foundation, Alexandria, Virginia.

Sanitation Districts of Los Angeles County (1977). *Pomona Virus Study - Final Report*. Report prepared by Sanitation Districts of Los Angeles County for California State Water Resources Control Board, Sacramento, CA.

State of California (2008). *Treatment Technology Report for Recycled Water- December 2009*, State of California Department of Public Health, Division of Drinking Water and Environmental Management, Recycled Water Unit, Carpentaria, California.

Tchobanoglous, G., F.L. Burton, and H.D. Stensel (2003). *Wastewater Engineering: Treatment and Reuse*, 4th ed., Metcalf and Eddy, Inc., McGraw-Hill Book Company, New York.

U.S. EPA (2003). *LT1ESWTR Disinfection Profiling and Benchmarking Technical Guidance Manual*, U.S. Environmental Protection Agency, Washington, DC.

APPENDIX 1-1: NWRI INDEPENDENT ADVISORY PANEL MEMBERS

NATIONAL WATER RESEARCH INSTITUTE

NWRI Independent Advisory Panel for: California Department of Public Health Review of Water Recycling Criteria for Agricultural Irrigation

ROBERT C. COOPER, PH.D. (Panel Chair)

*Professor Emeritus, School of Public Health, University of California, Berkeley
Vice President, BioVir Laboratories, Inc. (Benicia, California)*

Robert Cooper is Professor Emeritus of the School of Public Health at the University of California, Berkeley, where he served for 33 years and was Director of the University's Sanitary Engineering and Environmental Health Research Laboratory from 1980-1991. He also served in the United States Army Medical Corps and retired from the United States Public Health Service Reserve. Cooper has extensive experience in the field of water quality, infectious disease, and public health, and has published more than 70 papers on water quality and infectious disease. In addition, he has served on federal, state, and local government panels and committees dealing with these and related issues. At present, he is Vice President of BioVir Laboratories, Inc., a laboratory devoted to environmental microbiology. Cooper received a B.S. in Public Health from the University of California, Berkeley, and both an M.S. and Ph.D. in Microbiology from Michigan State University.

ADAM W. OLIVIERI, DR. P.H., P.E. (Vice Chair)

*Vice President
EOA, Inc. (Oakland, California)*

Adam Olivieri has 35 years of experience in the technical and regulatory aspects of water recycling, groundwater contamination by hazardous materials, water quality and public health risk assessments, water quality planning, wastewater facility planning, urban runoff management, and on-site waste treatment systems. He has gained this experience through working as a staff engineer with the California Regional Water Quality Control Board (San Francisco Bay Region), as staff specialist (and Post-doc fellow) with the School of Public Health at the University of California, Berkeley, project manager/researcher for the Public Health Institute, and as a consulting engineer. He is currently the Vice president of EOA, Inc., where he manages a variety of projects, including serving as Santa Clara County Urban Runoff Program's Manager since 1998. Olivieri is also the author or co-author of numerous technical publications and project reports. He received a B.S. in Civil Engineering from the University of Connecticut, an M.S. in Civil and Sanitary Engineering from the University of Connecticut, and both an MPH and Dr.PH in Environmental Health Sciences from University of California, Berkeley.

MICHAEL D. CAHN, PH.D.

Irrigation and Water Resources Advisor

University of California, Cooperative Extension (Salinas, California)

Michael Cahn has worked for the University of California, Cooperative Extension since 1995, first as a vegetable and row crop advisor in the Sacramento Valley, and since 2001 as an Irrigation and Water Resources Advisor based in Monterey County. He also works in the central coast counties of San Benito, Santa Clara, Santa Cruz, and San Mateo. His research and extension activities are focused in the areas of irrigation technology, water management of vegetable and horticulture crops, food safety, and farm water quality. His areas of specialty include irrigation management of vegetable and row crops, water quality protection, salinity management, drip irrigation, fertility management of vegetables, and microbial food safety. Cahn received a B.S. in Soil and Water Science from the University of California, Davis, and a Masters and Ph.D. in Agronomy-Soil Science from Cornell University.

JOHN COLFORD, JR., M.D., PH.D., MPH

Professor of Epidemiology, School of Public Health

University of California, Berkeley (Berkeley, California)

John Colford is Professor of Epidemiology in the School of Public Health at the University of California, Berkeley. His research interests include waterborne infectious diseases (domestic, developing country, and recreational water settings), and clinical trial design (individual and community-level). His research frequently employs randomized, controlled trials as a study design. Dr. Colford has multiple peer-reviewed publications of both trial results and methodological issues in the design of trials. He is the Principal Investigator of National Institutes of Health (NIH)-funded, long-term individual and community trials in both the U.S. and developing world.

JAMES CROOK, PH.D., P.E.

Water Reuse Consultant (Boston, Massachusetts)

Jim Crook is an environmental engineer with 40 years of experience in state government and consulting engineering arenas, serving public and private sectors in the U.S. and abroad. He has authored more than 100 publications and is an internationally recognized expert in water reclamation and reuse. He has been involved in numerous projects and research activities involving public health, regulations and permitting, water quality, risk assessment, treatment technology, and all facets of water reuse. Crook spent 15 years directing the California Department of Public Health's water reuse program, during which time he developed California's first comprehensive water reuse criteria. He also spent 15 years with consulting firms overseeing water reuse activities and is now an independent consultant specializing in water reuse. He has served on several advisory panels and committees convened by the National Academy of Sciences, NWRI, and others. Among his honors, he was selected as the American Academy of Environmental Engineers' 2002 Kappe Lecturer and the WaterReuse Association's 2005 Person of the Year. Crook received a B.S. in Civil Engineering from the University of

Massachusetts and both an M.S. and Ph.D. in Environmental Engineering from the University of Cincinnati.

JEAN-FRANÇOIS DEBROUX, PH.D.

*Director, Advanced Technologies Group
Kennedy/Jenks Consultants (San Francisco, California)*

At Kennedy/Jenks Consultants, Jean Debroux serves as Director of the Advanced Technologies Group, which was formed to solve technologically challenging problems. Part of this effort includes performing pilot and field studies for regulated and emerging contaminants and evaluates the cost impacts of complying with Safe Drinking Water Act regulations. A water quality expert, Debroux has extensive experience and expertise working with water utilities and research organizations in water treatment and water reuse issues, and is an active member of the WaterReuse Foundation, where he serves on the Research Advisory Committee. Debroux received a B.S. in Chemical Engineering from the University of South Florida, and both an M.S. in Environmental Engineering and Ph.D. in Civil Engineering from the University of Colorado, Boulder. In addition, he attended the Environmental Management Institute at Tufts University and has served as a Post-Doctoral Research Fellow and Lecturer at Stanford University and as a Research Fellow at Université de Poitiers, France.

ROBERT MANDRELL, PH.D.

*Research Leader, Produce Safety and Microbiology Research Unit
U.S. Department of Agriculture, Agricultural Research Service (Albany, California)*

Robert Mandrell has served as Research Leader of the Produce Safety and Microbiology Research Unit at the U.S. Department of Agriculture (USDA) since 1996. His research interests include microbial food safety related to fresh produce, with an emphasis on the ecology and epidemiology of enteric pathogens in a major leafy greens production region in California; genomics and biology of *Campylobacter*, *Listeria* and *Salmonella* species related to food; Norovirus in the environment; and high-throughput methods for detection and characterization of foodborne pathogens. Prior to working with the USDA, Mandrell studied the human immune response to bacterial polysaccharide-conjugate vaccines and other topics at the Oakland Children's Hospital Research Institute; immunochemistry and biochemistry of lipooligosaccharides of *Neisseria meningitidis*, *Neisseria gonorrhoeae*, and *Haemophilus species* at the VA Medical Center in San Francisco; and conducted research at the Walter Reed Army Institute of Research, Department of Bacterial Diseases in Washington, DC. Mandrell received a B. S. in Microbiology from Ohio State University and a Ph.D. from the School of Biochemistry at the University of Birmingham in the United Kingdom.

TREVOR SUSLOW, PH.D.

*Extension Research Specialist, Department of Plant Sciences
University of California, Davis (Davis, California)*

Trevor Suslow is the Extension Research Specialist in the Department of Plant Sciences at the University of California, Davis, having statewide responsibilities in the quality and safety of perishable horticultural commodities. His program involves preharvest and postharvest research and outreach education on diverse fresh and fresh-cut horticultural foods. His emphasis is on microbial safety and disinfection within the pre-harvest and postharvest environment and postharvest pathology. Additional interests include biological control and other biologically mediated controls of postharvest diseases and pathogens of human food safety concern. He also served as a member of numerous panels, most recently for the U.S. Department of Agriculture's Agriculture and Food Research Initiative (AFRI) and the Institute of Food Technologists. Suslow received a B.Sc. in Agricultural Sciences and Ph.D. in Plant Pathology from the University of California, Berkeley.

GEORGE TCHOBANOGLIOUS, PH.D., P.E., NAE

*Professor Emeritus
University of California, Davis (Davis, California)*

For over 37 years, wastewater expert George Tchobanoglous has taught courses on water and wastewater treatment and solid waste management at the University of California, Davis, where he is Professor Emeritus in the Department of Civil and Environmental Engineering. He has authored or coauthored over 350 publications, including 13 textbooks and five engineering reference books. Tchobanoglous has been past President of the Association of Environmental Engineering and Science Professors and currently serves as a national and international consultant to both government agencies and private concerns. Among his honors, he received the Athalie Richardson Irvine Clarke Prize from NWRI in 2003, was inducted to the National Academy of Engineers in 2004, and received an Honorary Doctor of Engineering degree from the Colorado School of Mines in 2005. Tchobanoglous received a B.S. in Civil Engineering from the University of the Pacific, an M.S. in Sanitary Engineering from the University of California, Berkeley, and a Ph.D. in Environmental Engineering from Stanford University.

APPENDIX 1-2: CDPH AGRICULTURAL IRRIGATION WITH RECYCLED WATER - THE CONCERNS

Are food crops irrigated with reclaimed water that has been produced in conformance with the California Water Recycling Criteria (Criteria) (Title 22, Sec. 60301, et seq.) safe?

A number of specific concerns have been raised regarding the Criteria's goal, assumptions, requirements, and implementation. Whereas CDPH would appreciate comments on the individual concerns, they are presented for the purpose of informing the Panel of the specific issues that collectively warrant the Panel review. This is a summary of those concerns.

The first five concerns are specific to requirements for effluent allowed for unrestricted food crop irrigation (Sec. 60304(a)). The effluent must be oxidized (secondary effluent) (Sec. 60301.650), filtered (Sec. 60301.320), and disinfected (Sec. 60301.230). These treatment and performance requirements include:

- 1) Secondary treatment that produces an oxidized wastewater in which the organic matter has been stabilized, is nonputrescible, and contains dissolved oxygen.
- 2) Effective granular media filtration to reduce turbidity to less than a daily average of 2 NTU, or membrane filtration to reduce turbidity to less than a daily average of 0.2 NTU.
- 3) Disinfection to ensure a minimum CT of 450 milligram-minutes per liter (based on total chlorine residual and minimum 90-minute modal contact time), or a disinfection process that provides a 5-log virus reduction when combined with the filtration removal.
- 4) Daily total coliform monitoring to verify compliance with a 2.2 MPN/100 mL 7-day median value.

The concerns include:

1) The Criteria may not ensure an essentially pathogen free water.

Joan Rose investigated the relationship between indicator organisms and pathogens in tertiary treated reclaimed water. This work is reported in "Validity of the Indicator Organism Paradigm for Pathogen Reduction in Reclaimed Water and Public Health Protection,"⁵ and "Reduction of Pathogens, Indicator Bacteria, and Alternative Indicators by Wastewater Treatment and Reclamation Processes."³ The fifth conclusion of the report states, "The production of reclaimed water using secondary activated sludge processes, filtration, and disinfection is not universally effective for removing pathogens. Viruses ranged in concentration from 0.3 to 3.3 MPN PFU/100L, *Giardia* cysts ranged from 6 to 390/100L, and *Cryptosporidium* ranged from 4.6 to 114 oocysts/100L in reclaimed water."

CDPH staff and representatives of the water reuse industry routinely characterize the Criteria's filtered and disinfected effluent as being "essentially pathogen free." Is this statement true? Is the statement the appropriate way to describe "safe" irrigation water (posing a 10^{-4} annual risk of infection)?

2) The Criteria may not ensure a 5-log virus reduction. The Pomona Virus Study⁴ (PVS) was the basis for guidelines used with the previous (1978) version of the Criteria to allow the use of direct filtration in lieu of complete treatment. The guideline was incorporated into the regulation in 2000. The study identified conditions under which direct filtration performed (virus reduction by removal and inactivation) as effectively as complete conventional filtration. The direct filtration virus seeding study demonstrated an average virus removal of approximately 1 log and average inactivation of approximately 4 log.

3) The 450 mg-min/L CT for chlorine disinfection may not ensure a 4-log virus inactivation. The FLEWR study provides evidence.

4) The filtration may not ensure a 1-log virus removal; therefore, multibarrier treatment may not be ensured. Studies of the Los Angeles Tillman plant, Monterey Regional plant (FLEWR study), and Dynasand filter study in San Francisco identified removals of less than 1 log. Multibarrier treatment for critical contaminants is a key principle of public health protection and has been assumed to occur in recycling. Should all filtration processes demonstrate virus removal?

5) The filtration performance standard of 2 NTU is not stringent, does not ensure parasite removal, and does not encourage the most effective filter designs or optimization of operation. In the Joan Rose paper, "Validity of the Indicator..." the adequacy of the existing turbidity standard to ensure an appropriate reduction in *Crypto* oocysts would appear to be an important issue. Joan's data suggest that there was little, if any, removal of *Crypto* oocysts through the filtration process (the paper does not provide information on filtered water quality, so it is unknown what the effluent turbidity levels were). In addition, approximately 20 percent of the filtered, disinfected samples were positive for viable oocysts at concentrations of about 2 to 10 oocysts per 100 liters. Filtration is the only effective barrier to *Crypto* if chlorine/chloramine disinfection is used.

The existing turbidity standard was based on the level that could be achieved by tertiary treatment plants operating in the 1970s.

6) Are the microbial risk assessments (Tanaka et al.¹ and Asano et al.²) that have been relied upon by CDPH to confirm that the Criteria achieve the acceptable risk goal for reuse (10^{-4} annual chance of infection) sufficient? Is there a need for updated assessments addressing *Giardia* and *Cryptosporidium*?

7) Is the requirement for an oxidized effluent sufficient to ensure a secondary effluent that can be reliably filtered and/or disinfected? Secondary effluent, depending on the treatment used (Pond, TF, AS, and MBR) and operation, can vary widely in particle and chemical content. Should acceptable secondary treatment processes be defined and coupled with specific performance criteria (e.g., BOD, TSS)?

8) Is coliform a good choice for a disinfection performance standard? See the Rose studies.

9) Can crops take up pathogenic virus or toxic chemicals from the irrigation water? This contamination pathway is not addressed in the Criteria.

10) The structure of the Criteria may not be design to facilitate compliance and enforcement. The nine Regional Water Quality Control Boards regulate reuse projects. The extent to which agricultural irrigation with reclaimed water in California complies with the Criteria is unknown. There is a suspicion that compliance is spotty, and that certain assumptions built into the Criteria (such as the adequacy of secondary treatment and the crop irrigation and handling practices) may be responsible.

11) Should the criteria require a distribution system disinfectant residual? A distribution system residual requirement to address aesthetic (odor), operational (sprinkler fowling), and potential growth of opportunistic pathogen concerns has been recommended. The Water Code only gives CDPH authority to address public health concerns. Although opportunistic pathogens are a public health issue, there has not been information that supports a regulation (the necessity for a requirement must be demonstrated).

12) McGowan concerns. CDPH should developed criteria that address pathogens (specific?), antibiotic-resistant genetic material, antibiotic resistance, and the buildup of antibiotics, such as macrolides, that can maintain vancomycin resistance.

13) Approving increased filtration rates. The criteria set a limit of 5 gpm/sq. ft. based on the PVS. Many existing and proposed reuse projects would benefit from the economy achieved by operating filters at hydraulic loading rates higher than those authorized in the Criteria. Increased loading rates can be permitted under the existing criteria when “equivalent level of treatment.” As hydraulic load increases, and water velocity increases past the filter media, most of the mechanisms that allow a filter to remove particles degrade and performance deteriorates. True equivalence of treatment usually requires some modification of the treatment process to offset the effects of the rate increase.

References

1. Tanaka, H.; Asano, T.; Schroeder, E.; Tchobanoglous, G.; “Estimating the Safety of Wastewater Reclamation and Reuse Using Enteric Virus Monitoring Data,” Water Environment Federation, January/February 1998.
2. Asano, T.; Leong, L.Y.C.; Rigby, M.; Sakaji, R.; “Evaluation of the California Wastewater Reclamation Criteria Using Enteric Virus Monitoring Data,” 1992, *Water Science Technology*, Vol. 26, pp. 1513-1524.
3. Rose, J.; Farrah, S.; Harwood, V.; Levine, A.; Lukasik, J.; Scott, T.; “Reduction of Pathogens, Indicator Bacteria, and Alternative Indicators by Wastewater Treatment and Reclamation Processes,” 2004, WERF.

4. County Sanitation Districts of Los Angeles County (1977), "Pomona Virus Study, Final Report," Prepared for California State Water Resources Control Board, Sacramento, Calif., and USEPA, Washington, D.C.

5. Harwood, V.; Levine, A.; Scott, T.; Chivukula, V.; Lukasik, J.; Farrah, S.; Rose, J.; "Validity of the Indicator Organism Paradigm for Pathogen Reduction in Reclaimed Water and Public Health Protection," *Applied and Environmental Microbiology*, June 2005, p. 3163-3170, Vol. 71, No. 6).

6. FLEWR reference needed (Kara Nelson paper).

7. Pomona Virus Study, Sanitation Districts of Los Angeles County, 1977.

APPENDIX 1-3: PANEL MEETING NOTES AND PRESENTATIONS

NATIONAL WATER RESEARCH INSTITUTE

Ag Panel Meeting February 21, 2012

Meeting Notes

Meeting Attendance: Robert C. Cooper, Ph. D. (Panel Chair), Adam W. Olivieri, Dr. PH, P.E. (Vice Chair), John Colford, Jr., MD, PhD, MPH, James Crook, Ph.D., P.E., Jean-François Debroux, Ph.D., Robert Mandrell, Ph.D. , Edmund Seto, Ph.D. , Trevor Suslow, Ph.D., George Tchobanoglous, Ph.D., P.E.

CDPH Staff: David Spath, Ph.D., P.E., Robert Hultquist, M.S., P.E.

NWRI staff: Jeff Mosher and Gina Vartanian

1. Welcome and Introduction (see Introduction slides)

- a. The Panel review the overall CDPH scope:
 - i. "...whether recycled water produced in conformance with California's Water Recycling Criteria is sufficiently protective of public health for agricultural food crop irrigation."
- b. Comment: **For the report, put in report introduction what "the Panel decided needed to be covered" and "what did not cover."**
- c. Reviewed the meeting agenda.
- d. Reviewed the 9 questions the Panel is addressing.

2. Preliminary QMRA Results, discussion and Panel Direction (Question 1)

- a. Reviewed model approach and model assumptions (Seto presentation – see slides)
 - i. Pathogens of concern (*Cryptosporidium parvum*, *Giardia lamblia*, enterovirus (represented by rotavirus), and E. coli O157)
 - ii. Occurrence in reclaimed water
 - iii. Pathogen removal
 - iv. End uses and exposure pathways
 - v. Dose response relationships
- b. Issues from last meeting
 - i. Verify treatment efficacy from Rose 2004
 - ii. Confirm consistency of the treatment efficacies with other studies
 - iii. Generate preliminary risk estimates for NWRI Panel discussion
 - iv. Consider the sensitivity of modeling assumptions
- c. Verify treatment efficacy from Rose 2004
 - i. Completed additional it review and compared Rose results against a number of additional studies including recent pathogen data from 2009 WERF EBMUD, 13 years of Monterey data and recent Sacramento data.

- ii. Received permission from City of Vacaville to review their plant performance data (parasite pathogen data) against Ag Panels literature review. Will be done as a separate analysis since performance appears to be substantially better than other data.
 - iii. Review of literature review against Rose data indicates that results are within the range of data and that Rose data seem consistent with other literature review findings.
- d. Confirm consistency of the treatment efficacies with other studies
 - i. Fitted Rose data to normal and calculated log removals. Relying mean as more conservative estimate (based on the distribution) than the median – since tails out
 - ii. Review of log removals across plants does not indicate one plant in Rose dataset is an outlier
 - iii. Log removals appear consistent with literature estimates
- e. Generate preliminary risk estimates for NWRI Panel discussion
 - i. Evaluated 3 reuse scenarios:
 1. Scenario #1: full Title 22 (tertiary) with irrigation on food crops – direct contact (no decay in field and daily consumption of lettuce)
 2. Scenario #2: secondary undisinfectated reuse on orchards and vineyards (no direct contact and with daily consumption)
 3. Scenario #3: secondary disinfected reuse on food crops above ground (no direct contact and daily consumption)
 - ii. SUMMARY OF PRELIMINARY FINDINGS (based on above assumptions)
 1. Scenario 1 – median risk of infection between 10⁻⁵ and 10⁻⁸ per exposure event (annualized risk between 10⁻⁵ and 10⁻³)
 2. Scenario 2 – median annualized risk between 10⁻³ and 10⁻²)
 3. Scenario 3 – median annualized risk between 10⁻⁴ and 10⁻³)
- f. Consider the sensitivity of modeling assumptions
 - i. Using enteric virus and consumption of crop that comes into direct contact with irrigation water as a case study, sensitivity analyses of median annual risk show:
 1. Medium sensitivity to exposure assumptions (~2 log)
 2. Large sensitivity to environmental decay assumptions (~4-6 logs)
 3. Small sensitivity to exposure frequency assumptions (~1 log)
 4. Medium sensitivity to treatment assumptions (~1 log risk per 1 log removal)
 - ii. Discussion points including Panel Guidance and Direction:
 1. Does decay happen in environment?
 - a. 5 log reduction (“environmental decay”) assumed by Tanaka (based on publication footnote)
 - b. QMRA model reproduces Tanaka results
 - c. Huge sensitivities based on time (1d, 7 d, 14 d)
 - d. Trevor noted that EPA pesticide guidance assumptions for harvesting after spray irrigation range from 1 to 7 days. He noted that 4-5 days is the general practice. (*Trevor will provide citation*).

- e. Panel agreed that environmental decay should be assumed 4-5 days based on general practice.
2. Is the consumption of irrigated food crops such as lettuce, grapes, nuts everyday an appropriate assumption?
 - a. Probably not – rely on FDA food averages
 - b. Illustrate sensitivity of assumption in analysis and report (bound with upper and lower food consumption estimates).
 - c. Adjust consumption based on percentage of recycled water currently used for food crop irrigation in CA with an allowance for future growth (rely on SWRCB recent reuse estimates). Apply adjustment to all three scenarios.
3. Is the assumption regarding the consumption of 0.1mL/event reasonable for Scenario II and III?
 - a. Panel suggested that this may be high and should be investigated and documented in possible.
 - b. Panel suggested bounding estimates between 0.01 and 0.1 as well.
4. Should norovirus dose response (DR) be utilized instead of rotavirus?
 - a. The comparison between rotavirus and norovirus dose response is complicated by the fact that the dose units are different.
 - b. Rotavirus DR is based on dose in pfu. Norovirus DR is based on dose in qPCR genomes.
 - c. Rotavirus produces the highest risk of infection without harmonizing the dose units.
 - d. Enteric virus concentration data is "MPN"/volume which complicates matters more using norovirus DR.
 - e. Based on above discussion the Panel concurred that the rotavirus DR continue to be applied.
 - f. The Panel noted that DPH should follow developments associated with the norovirus DR and evaluate as needed in the future.
5. Should adenovirus be considered as a pathogen of concern as part of the QMRA?
 - a. Edmund presented a literature review for treatment plant performance.
 - b. The results were influenced by the rather large numbers reported present in effluents and the degree related to the detection method in which RT-PCR values are much higher than culture (cell culture) values (about 3 orders of magnitude as noted above).
 - c. The data are based on infection (“colonization”) not disease. The public health significance of adenovirus in water was discussed. There are reports of Adenovirus caused illness, including enteric,

- occurring but these incidents involve exposure to immune compromised cohorts and exposure via swimming pools.
- d. DR relationship is based on Couch (1966) which is an inhalation study and all current exposure assumptions are based on ingestion.
 - e. Based on the available data it would seem that adenovirus colonization is prevalent in most communities. There was some discussion that since there is no apparent Public Health problem associated with this virus group (other than that faced by immune compromised individuals to any number of microbial agents) that it should be dropped from the list of pathogens of concern for this review. Mention in report including rationale for not considering. Include treatment literature review in appendix without preliminary QMRA since DR assumption is not appropriate for ingestion.

6. Should the Panel include secondary infection?

- a. Edmund noted that the complexity of modeling becomes difficult (need right assumptions – immunity).
- b. Adam noted that as part of the WERF 2004 development of QMRA tools the question of convergence using a dynamic vs. static model was investigated. The analysis indicated that generally as acceptable risk levels approached <1/10,000 per year for low doses that the static and dynamic model estimates were similar.
- c. Dave Spath noted that CDPH needs to maintain consistency across regulations
- d. The Panel noted that the report should include a brief discussion and rationale for use of the static model.

3. **Q2: Acceptable risk?** Adam and Jack (see slides)

i. Adam briefed the Panel on Question 2

- 1. Can't be defined by Panel – but can look at question from a weight of evidence standpoint
 - a. Define other regulatory examples
 - b. CDPH background and previous assumptions
 - c. QMRA examples (including current QMRA results)
 - d. Overall comparison of current assumptions to national diarrheal disease incidence

ii. Panel Conclusion (after considerable discussion)

- 1. No need for CDPH to develop an “acceptable” or “tolerable” risk metric for Title 22 reuse applications (add a statement regarding current CDPH goal is de minimis)
- 2. Review of the available weight of evidence confirms that the current Ag practices done consistent with Title 22 do not increase public health risk

3. Tightening the Title 22 standards will not improve public health

4. **Questions 3,4,5,6,7** – Jim Crook (see slides)

- a. Q 3 – basis for 5-log and Q 4 – basis for 450 CT – Pomona virus study
 - i. Required CT should be based on form of chlorine – combined or free
 - ii. Lower CT is warranted for disinfection of ammonia free effluent
 - iii. Inappropriate to use drinking water CT criteria
 - iv. CDPH can address consideration for other methods of treatment through Section 60320.5

- b. Q 5 – How to define multiple barriers –
 - i. Historically main pathogen of concern was enteroviruses
 - ii. Treatment processes (primary, secondary and tertiary-filtration) can reduce pathogens of concern
 - iii. Disinfection is key barrier
 - iv. Emphasis should be placed efficacy and reliability of disinfection process

- c. Q 6 – Is current <2 NTU turbidity still valid performance standard –
 - i. Current standard is valid and should be maintained as compliance standard until more sophisticated approach evaluated, for example particle counter
 - ii. Rationale for <0.2 NTU if membranes are used needs clarification
 - iii. If membranes are used CT or UV requirements should be modified to account for better water quality and this can and should be done under current Title 22 regulations

- d. Q 7 – Should performance standard be used to define secondary treatment –
 - i. Provide some information in the report based on the US EPA CWA definition of secondary treatment
 - ii. CDPH should work with the SWRCB to utilize a consistent approach in discharge requirements

- e. Other methods of treatment
 - i. Section 60320.5 can and should be used to assess other treatment process and Title 22 related requirements
 - ii. The questions was raised relative to the need for another Pomona-type virus study
 - 1. Several Panel members noted that UC Davis developed a scope to address pathogen removal and inactivation as part of a WRRF sponsored study (Darby et.al., 2006 – WRF -03-001)
 - 2. The WRRF scope will be distributed for consideration by the Panel as input to CDPH as part of the current Panel report

5. **Question 8** – Bob Cooper (see slides)

- a. Are total coliforms still an appropriate indicator of overall disinfection performance in the treatment of wastewater to be used on food crops?
- b. Yes
 - i. Successful history for more than a century
 - ii. Experience

1. Most conservative indicator of plant performance followed by fecal coliforms and *E. coli* in that order
- iii. Alternatives
 1. No practical and time proven alternative to the coliform standard
 2. Subsets of total coliform have been suggested as being more indicative of sanitary quality (fecal coliform and *Escherichia coli*) for which assay methods are available
 3. The develop of new indicators assays based on molecular biological methods are in the wings but thus far are not practical for routine monitoring or shown to be superior to the coliform std

6. Question 9 – Robert Mandrell

- a. Do crops take up pathogenic viruses?
 - i. Based on evaluation of some 38 references including a review of infectious doses for various pathogens (*Salmonella*, norovirus, *Cryptosporidium*)
 1. Infectious doses are high enough to cause an infection but no evidence of problem
 2. Early studies (1950s) on viruses indicates that plants can internalize when roots were cut
 3. No internalization studies for field applications
 4. No definitive links of issues with reclaimed water and fresh produce
 - b. Panels Bottom line – There have been No definitive links to Any outbreaks (illustrate this conclusion with a brief discussion of the Monterey reuse project)

7. Next Steps

- a. Schedule (Revised Based on Discussion with CDPH and SWRCB staff as part of Debrief)
 1. Panel Provides Text for Report to Jeff and Adam – March 5
 2. Draft Report distributed to Panel – April 2
 3. Internal Panel Comments and Edits Due – April 16
 4. Provide Draft Report to DPH – April 23
 5. DPH comments/questions due – May 14
 6. Final Out to Panel for Review – May 21
 7. Final Edits Due – May 25
 8. Final Report to DPH – May 31

8. DEBRIEF CDPH (2 pm)

On phone:

- Brian Bernados, David Balgobin (State Water Board), Randy Barnard, Lynda Dyane, and Mark Bartson.

Meeting Notes

- Bob Hultquist provided a brief introduction, including purpose of Panel.
- Conference call attendees were asked by Bob H to introduce themselves.
- Panel members introduced themselves. Jeff M mentioned Michael Kahn couldn't attend the meeting, but will be briefed after the meeting.
- Adam O quickly went through select slides that Panel reviewed earlier that morning (slides on main review objectives, priority questions Q1-Q2).
- Jim Crook quickly went over priority question slides on Q3, Q4, Q5, Q6, and Q7.

- Adam quickly went over priority questions Q8 and Q9.
- Adam stated that a risk assessment effort was undertaken with Edmond Seto.
- Jeff M asked CDPH for input on the Panel schedule.
- Mark B: final deliverable to state by May 31
- David B: contract between CDPH and State Board ends end of June. We can be flexible on the schedule if it gives the Panel more time to make appropriate comments. As long as you don't push the June 30th date, we can be flexible.
- Jeff: end of May would allow us more time for Panel review.
- Adam: we will rework the internal schedule based on May 31 (see revised schedule above)
- Jeff: CDPH will want to see the response to their edits prior to finalization. Will give CDPH a week or less to review those final comments in Track Changes.
- Bob H: CDPH will not really need 3 weeks for review of draft report.
- Brian: I appreciate the summary. Question, Jim please elaborate on CT issue: current safety factor incorporated is OK – what safety factor did we have currently?
 - Jim: Don't use drinking water CT with wastewater because there could be other things in the water that could affect disinfection.
 - George: we will have a future directions section. Plants in future will nitrify; free residual will make sense for those plants. That should be a consideration that CDPH should work on in the future.
 - Brian: we are all ears on how to handle the free residual question. Any broad guidance will be helpful. Do we use a safety factor of 3?
- Bob H: I think the Panel is producing what we need.
- Brian: interested in discussion of membranes with the lower standard of turbidity.
 - Jim: We think credit should be given to some treatment with lower turbidity
- David: please send a copy of questions raised at this meeting. Jeff said we will email it to you.

**NWRI Independent Advisory Panel for:
California Department of Public Health (CDPH)**

***Review of CDPH Water Recycling Criteria -
Relative to Exposure to Microbial Agents for
Agricultural Irrigation***

Panel Meeting
February 21, 2012

Main Review Objective

Panel to consider whether recycled water produced in conformance with California's Water Recycling Criteria is sufficiently protective of public health for agricultural food crop irrigation.

Subjects/Issues To Consider

- Public health objectives and structure of the criteria
- Microbial risk assessments (new and previous) information including parasites
- Filtration requirements, including the turbidity performance standard, acceptable filter designs, filter loading rate, and treatment optimization.
- Disinfection requirements, including the coliform performance standard
- (CT) required for disinfection
- Use area crop handling, irrigation practice assumptions, and other best management practices.
- Treatment reliability requirements.
- Monitoring requirements.
- Role of multi-barrier treatment.

Agenda

- 9:00 am Welcome and Introductions & Review Agenda
- 9:20 am Brief Review of Panel Overall Charge
- 9:30 am Review of Questions and Responses
Action: Modify/clarify responses as needed
- 11:30 am Microbial Risk Assessment Assumptions, Approach, and Findings
- Noon WORKING LUNCH (provided)
- 12:30 pm Continue Panel Review of Questions/Responses
- 2:00 pm Debrief CDHP and SWRCB Staff
- 3:30 pm Adjourn

Priority Questions Selected by Panel for Review

Q1- How to characterize acceptable (safe) recycled water for irrigation?

Q2 - What is the basis/support for the current assumption that "essentially pathogen free" is comparable to a 1 in 10,000 annual risk of infection? Is this level of public health risk and the associated assumptions appropriate for agricultural irrigation (AI) associated exposures? If not, what are appropriate assumptions regarding an acceptable/tolerable public health risk?

Q3 - What is the basis for the current 5-log virus reduction criteria? Is the criteria still relevant? If not, how should it be modified (including potential indicator organism)? (Needs to be coordinated with #8)

Questions (cont'd)

Q4 - What is the basis for the 450 mg-min/L CT chlorine disinfection criteria? Is this CT level appropriate and if not, how should it be modified?

Q5 - How should multi-barrier treatment and effectiveness be defined? How should it be evaluated?

Q6 - Is the current <2 NTU (average daily) turbidity criteria still a valid filtration performance standard? If not, how should it be modified?

Questions (Cont'd)

Q7 - Should performance standards be used to define/characterize secondary treatment? If yes, how should they be described?

Q8 - Are total coliforms still an appropriate indicator of overall disinfection performance? If not, how should it be modified?

Q9 - Do crops take up pathogenic viruses? If yes, is this route of exposure a public health concern regarding AI water recycling?

Review and Consider Responses to Questions

- MRA and Questions 1 and 2
- Q's 3, 4, 5, 6, 7 and other treatment
- Q 8 and relevancy of TC today
- Q 9

MRA Results and Q1 & 2

- MRA Results
- Q1- How to characterize acceptable (safe) recycled water for irrigation?
- Q2 - What is the basis/support for the current assumption that “essentially pathogen free” is comparable to a 1 in 10,000 annual risk of infection? Is this level of public health risk and the associated assumptions appropriate for agricultural irrigation (AI) associated exposures? If not, what are appropriate assumptions regarding an acceptable/tolerable public health risk?

Summary of Q 3, 4, 5, 6, 7 & Other Treatment

- CT (450) – Q3 and Q4
- Multiple Barriers – Q5
- Turbidity – Q6
- Oxidized Wastewater – Q7
- Other Methods of Treatment – Q13 (extra credit)

Question 8

- Q8 - Are total coliforms still an appropriate indicator of overall disinfection performance? If not, how should it be modified?

Question 9

- Q9 - Do crops take up pathogenic viruses? If yes, is this route of exposure a public health concern regarding AI water recycling?

Next Steps

- Panel Provides Text for Report to Jeff and Adam – March 5
- Draft Report distributed to Panel – April 2
- Internal Panel Comments and Edits Due – April 16
- Provide Draft Report to DPH – April 23
- DPH comments/questions due – May 14
- Final Out to Panel for Review – May 21
- Final Edits Due – May 25
- Final Report to DPH – May 31

NWRI Agricultural Reuse QMRA

Edmund Seto, PhD

2/21/2012

Review: Quantitative Microbial Risk Assessment (QMRA) Framework

- A quantitative framework for estimating the relative risks associated with reclaimed water use that considers the following factors:
 - Pathogens of concern, and their occurrence in reclaimed water
 - Pathogen removal through different treatment processes
 - End uses and use-specific exposure pathways
 - Dose-response relationships between pathogen exposure and health endpoints

Review: Role of QMRA for the NWRI Advisory Panel

- Integrate existing and potentially improved knowledge on the aforementioned risk-relevant factors
- Assess the public health risks associated with recycled water for irrigation of agricultural food crops in California.
- Produce risk estimates helpful for subsequent risk management activities.

Review: QMRA models

- Static (individual-based) model

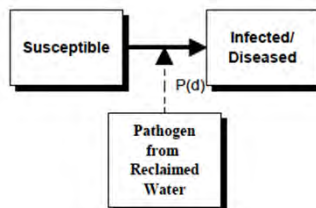

- Individuals are represented by 2 (or 3) epidemiological states: a susceptible state, an infected state, and/or a diseased state.
- The probability of infection (moving from the susceptible to the infected state) is governed by a dose-response relationship.
- The dose-response relationship depends upon the pathogen and exposure scenario being considered.
- Dose-response relationships may estimate the probability of *infection* or of *illness*. If the former, and the goal is to assess the risk of illness, the probability of presenting symptoms if infected can be considered.

Review: QMRA models

- Dynamic (population-based) model

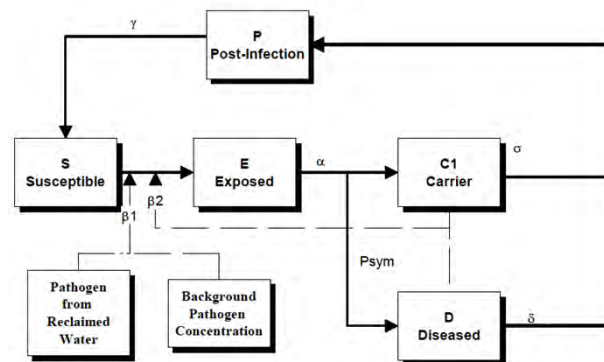

- More epidemiologic states to capture the transmission dynamics, e.g., immunity (P) and secondary transmission (β_2).

Issues raised at last meeting

- Need to verify treatment efficacy from Rose, et al, 2004
- Confirm consistency of the treatment efficacies with other studies
- Generate preliminary risk estimates for NWRI panel discussion
- Consider the sensitivity of modeling assumptions

Appendix 1-3 Continued: Presentations

SAMPLE NUMBER	Enterovirus				Log removal inflow -> disinfected	Log removal secondary -> disinfected	Log removal filtered -> disinfected	mean Log removal plant-specific inflow -> disinfected	mean Log removal plant-specific secondary -> disinfected	mean Log removal plant-specific filtered -> disinfected
	Inflow MPN/100L	Secondary MPN/100L	Filtered MPN/100L	Disinfected MPN/100L						
A-1	2.22E+02	1.70E+00	3.00E-01	3.00E-01	2.87E+00	7.53E-01	0.00E+00			
A-2	4.45E+02	2.00E+00	8.00E-01	3.00E-01	3.17E+00	8.24E-01	4.26E-01			
A-3	8.01E+02	5.86E+00	1.50E+00	8.00E-01	3.00E+00	8.64E-01	2.73E-01			
A-4	8.30E+02	8.90E+00	4.40E+00	1.50E+00	2.74E+00	7.73E-01	4.67E-01			
A-5	1.70E+03	3.86E+01	1.45E+01	1.45E+01	2.07E+00	4.24E-01	0.00E+00	2.77E+00	7.28E-01	2.33E-01
B-1	7.20E+02	5.80E+00	1.00E+00	3.00E-01	3.38E+00	1.29E+00	5.23E-01			
B-2	2.70E+03	1.10E+01	1.10E+00	4.80E-01	3.75E+00	1.36E+00	3.66E-01			
B-3	4.10E+03	4.70E+01	1.30E+00	9.10E-01	3.65E+00	1.71E+00	1.55E-01			
B-4	1.10E+04	6.20E+01	1.40E+00	1.20E+00	3.96E+00	1.71E+00	6.69E-02			
B-5	5.30E+04	8.00E+01	1.90E+00	1.26E+00	4.62E+00	1.80E+00	1.78E-01			
B-6			5.10E+00							
B-7								3.87E+00	1.58E+00	2.57E-01
C-1	4.00E+03	3.50E+01	8.30E+00	3.00E-01	4.12E+00	2.07E+00	1.44E+00			
C-2	6.30E+03	9.60E+01	9.20E+00	3.00E-01	4.32E+00	2.51E+00	1.49E+00			
C-3	2.20E+04	2.00E+02	1.40E+01	3.40E-01	4.81E+00	2.77E+00	1.61E+00			
C-4	2.30E+04	2.30E+02	4.90E+01	1.40E+00	4.22E+00	2.22E+00	1.54E+00			
C-5	6.30E+04	2.70E+02	5.10E+01							
C-6										
C-7								4.37E+00	2.39E+00	1.52E+00
D-1	2.84E+02	2.50E+00	1.10E+00	2.90E-01	2.99E+00	9.36E-01	5.79E-01			
D-2	7.37E+02	2.90E+00	1.20E+00	3.00E-01	3.39E+00	9.85E-01	6.02E-01			
D-3	9.21E+02	3.00E+00	2.40E+00	3.00E-01	3.49E+00	1.00E+00	9.03E-01			
D-4	1.39E+03	4.00E+00	3.00E+00	3.00E-01	3.67E+00	1.12E+00	1.00E+00			
D-5	3.97E+03	8.80E+00	4.10E+00	3.00E-01	4.12E+00	1.47E+00	1.14E+00			
D-6	5.08E+03	8.90E+00	4.20E+00	3.80E-01	4.12E+00	1.37E+00	1.04E+00			
D-7								3.63E+00	1.15E+00	8.77E-01
E-1	1.84E+02	5.00E-01	2.80E-01	3.00E-01	2.79E+00	2.22E-01	0.00E+00			
E-2	2.27E+02	5.00E-01	3.50E-01	3.60E-01	2.80E+00	1.43E-01	0.00E+00			
E-3	3.01E+02	5.20E+00	4.40E-01	3.70E-01	2.91E+00	1.15E+00	7.53E-02			
E-4	6.59E+02	8.70E+00	1.25E+00	1.10E+00	2.78E+00	8.98E-01	5.55E-02	2.82E+00	6.03E-01	3.27E-02
F-1	1.10E+03	2.20E+00	1.10E+00	2.90E-01	3.59E+00	8.80E-01	5.78E-01			
F-2	3.40E+03	5.90E+00	1.10E+00	3.00E-01	4.05E+00	1.29E+00	5.64E-01			
F-3	4.50E+03	1.10E+01	1.40E+00	3.20E-01	4.15E+00	1.54E+00	6.41E-01			
F-4	3.20E+04	2.00E+01	3.00E+00	3.70E-01	4.94E+00	1.73E+00	9.09E-01			
F-5	3.50E+04	2.60E+01	4.30E+00	4.00E-01	4.94E+00	1.81E+00	1.03E+00			
F-6										
F-7								4.33E+00	1.45E+00	7.45E-01
mean	9.45E+03	4.01E+01	6.26E+00	1.02E+00	3.63E+00	1.30E+00	6.09E-01			
SD	1.62E+04	7.04E+01	1.22E+01	2.63E+00	7.45E-01	6.31E-01	5.11E-01			

SAMPLE NUMBER	giardia				Log removal inflow -> disinfected	Log removal secondary -> disinfected	Log removal filtered -> disinfected	mean Log removal plant-specific inflow -> disinfected	mean Log removal plant-specific secondary -> disinfected	mean Log removal plant-specific filtered -> disinfected
	inflow cysts/100L	Secondary cysts/100L	Filtered cysts/100L	Disinfected cysts/100L						
A-1	7.57E+02	1.90E+01	4.38E+01	1.38E+01	1.74E+00	1.39E-01	5.00E-01			
A-2	2.37E+03	2.11E+02	8.46E+01	7.17E+01	1.52E+00	4.69E-01	7.19E-02			
A-3	1.30E+04	2.00E+03	4.54E+02	5.12E+02	1.40E+00	5.92E-01	0.00E+00			
A-4	4.21E+05	2.20E+03	7.18E+02	6.42E+02	2.82E+00	5.35E-01	4.86E-02			
A-5	1.25E+06	1.40E+04	7.27E+02	7.06E+02	3.25E+00	1.30E+00	1.27E-02	2.15E+00	6.06E-01	1.27E-01
B-1	4.70E+03	1.38E+01	1.90E+00	2.00E+00	3.37E+00	8.42E-01	0.00E+00			
B-2	1.30E+04	3.10E+01	3.50E+00	5.60E+00	3.37E+00	7.43E-01	0.00E+00			
B-3	2.00E+04	7.14E+01	1.52E+01	1.27E+01	3.20E+00	7.50E-01	7.80E-02			
B-4	4.80E+04	1.23E+02	2.75E+01	1.78E+01	3.43E+00	8.40E-01	1.90E-01			
B-5	1.89E+05	1.43E+02	7.13E+01	3.39E+01	3.73E+00	6.25E-01	3.23E-01			
B-6	2.50E+05	6.21E+02	7.61E+01	6.63E+01	3.58E+00	9.72E-01	5.99E-02			
B-7								3.44E+00	7.95E-01	1.09E-01
C-1	2.00E+04	1.00E+01	3.89E+00							
C-2	2.20E+04	1.90E+01	4.00E+00	1.80E+00	4.09E+00	1.02E+00	3.47E-01			
C-3	3.57E+04	9.17E+01	4.08E+00	6.60E+00	3.73E+00	1.14E+00	0.00E+00			
C-4	3.40E+05	1.37E+02	5.50E+00	1.19E+01	4.46E+00	1.06E+00	0.00E+00			
C-5	5.90E+05	1.01E+03	1.07E+01	9.06E+01	3.81E+00	1.05E+00	0.00E+00			
C-6		9.35E+03	9.10E+01							
C-7								4.02E+00	1.07E+00	8.67E-02
D-1	9.10E+03	1.06E+01	3.00E+00	2.00E+00	3.66E+00	7.23E-01	1.76E-01			
D-2	1.13E+04	2.12E+01	5.18E+00	3.77E+00	3.48E+00	7.50E-01	1.38E-01			
D-3	1.54E+04	6.50E+01	5.28E+00	2.26E+01	2.83E+00	4.58E-01	0.00E+00			
D-4	2.10E+04	7.30E+01	1.05E+01	3.02E+01	2.84E+00	3.83E-01	0.00E+00			
D-5	1.34E+05	9.52E+01	6.30E+01	3.40E+01	3.60E+00	4.47E-01	2.68E-01			
D-6	2.01E+05	8.45E+03	1.74E+02	4.10E+01	3.69E+00	2.31E+00	6.28E-01			
D-7								3.38E+00	8.46E-01	2.02E-01
E-1	1.81E+04	4.10E+01	2.00E+00	7.80E+00	3.37E+00	7.21E-01	0.00E+00			
E-2	3.89E+04	5.50E+01	1.20E+01	8.00E+00	3.69E+00	8.37E-01	1.76E-01			
E-3	8.00E+04	1.06E+02	2.20E+01	3.48E+01	3.36E+00	4.84E-01	0.00E+00			
E-4	1.48E+05	2.41E+02	1.38E+02	4.60E+01	3.51E+00	7.19E-01	4.76E-01	3.48E+00	6.90E-01	1.63E-01
F-1	6.60E+02	3.57E+01	2.10E+00	2.00E+00	2.52E+00	1.25E+00	2.12E-02			
F-2	2.87E+03	1.95E+02	4.40E+00	2.00E+00	3.16E+00	1.99E+00	3.43E-01			
F-3	3.56E+03	3.74E+02	5.70E+00	2.00E+00	3.25E+00	2.27E+00	4.55E-01			
F-4	4.29E+03	5.28E+02	1.87E+01	5.20E+00	2.92E+00	2.01E+00	5.56E-01			
F-5	1.14E+04	9.22E+02	2.00E+01	1.30E+01	2.94E+00	1.85E+00	1.87E-01			
F-6	1.60E+05	9.35E+02	5.66E+01	1.60E+01	4.00E+00	1.77E+00	5.49E-01			
F-7								3.13E+00	1.88E+00	3.52E-01
mean	1.27E+05	1.28E+03	8.74E+01	7.95E+01	3.24E+00	1.00E+00	1.81E-01			
SD	2.48E+05	3.13E+03	1.84E+02	1.83E+02	6.94E-01	5.81E-01	2.05E-01			

Appendix 1-3 Continued: Presentations

SAMPLE NUMBER	crypto Inflow oocysts/100L	crypto Secondary oocysts/100L	crypto Filtered oocysts/100L	crypto Disinfected oocysts/100L	Log removal inflow -> disinfected	Log removal secondary -> disinfected	Log removal filtered -> disinfected	mean Log removal plant-specific inflow -> disinfected	mean Log removal plant-specific secondary -> disinfected	mean Log removal plant-specific filtered -> disinfected
A-1	6.60E+01	1.00E+01	3.50E+00	3.70E+00	1.25E+00	4.32E-01	0.00E+00			
A-2	7.57E+02	3.17E+01	1.06E+01	3.78E+00	2.30E+00	9.24E-01	4.48E-01			
A-3	1.06E+03	2.22E+02	6.10E+01	1.60E+01	1.82E+00	1.14E+00	5.81E-01			
A-4	2.89E+03	2.29E+02	1.12E+02	1.89E+01	2.18E+00	1.08E+00	7.73E-01			
A-5	3.84E+04	2.59E+02	1.96E+02	2.10E+01	3.26E+00	1.09E+00	9.70E-01	2.16E+00	9.34E-01	5.54E-01
B-1	4.76E+02	1.39E+01	2.20E+00	2.00E+00	2.38E+00	8.42E-01	4.14E-02			
B-2	1.70E+03	1.76E+01	3.90E+00	2.30E+00	2.87E+00	8.84E-01	2.29E-01			
B-3	2.00E+03	3.10E+01	5.90E+00	2.80E+00	2.85E+00	1.04E+00	3.24E-01			
B-4	6.70E+03	6.12E+01	8.60E+00	4.20E+00	3.20E+00	1.16E+00	3.11E-01			
B-5	7.09E+03	1.03E+02	1.40E+01	4.40E+00	3.21E+00	1.37E+00	5.03E-01			
B-6	3.80E+04	1.79E+02		1.18E+01	3.51E+00	1.18E+00	0.00E+00	3.00E+00	1.08E+00	2.35E-01
B-7										
C-1	4.35E+02	1.00E+01	2.77E+00							
C-2	4.40E+02	1.28E+01	3.89E+00	2.20E+00	2.30E+00	7.65E-01	2.48E-01			
C-3	8.16E+02	1.37E+01	4.08E+00	1.48E+01	1.74E+00	0.00E+00	0.00E+00			
C-4	5.60E+03	1.83E+01	4.13E+00	1.22E+02	1.68E+00	0.00E+00	0.00E+00			
C-5	1.10E+04	6.15E+02	1.57E+02	3.17E+02	1.54E+00	2.88E-01	0.00E+00			
C-6		6.79E+02	1.06E+03					1.81E+00	2.63E-01	6.19E-02
C-7										
D-1	3.03E+02	1.06E+01	5.18E+00	3.77E+00	1.91E+00	4.48E-01	1.38E-01			
D-2	3.11E+02	1.06E+01	5.29E+00	7.55E+00	1.81E+00	1.47E-01	0.00E+00			
D-3	3.31E+02	2.12E+01	1.06E+01	7.55E+00	1.84E+00	4.48E-01	1.47E-01			
D-4	3.84E+02	2.12E+01	2.11E+01	4.53E-01	9.28E-01	0.00E+00	0.00E+00			
D-5	1.75E+04	2.70E+01	5.90E+01	5.30E+01	2.52E+00	0.00E+00	4.66E-02			
D-6	2.63E+04	3.45E+02	2.75E+02	1.79E+02	2.17E+00	2.87E-01	1.89E-01			
D-7								1.80E+00	2.22E-01	8.68E-02
E-1	1.50E+03	1.80E+01	1.00E+00	3.90E+00	2.59E+00	6.64E-01	0.00E+00			
E-2	2.10E+03	2.10E+01	1.10E+01	4.00E+00	2.72E+00	7.20E-01	4.39E-01			
E-3	1.23E+04	4.20E+01	1.20E+01	6.90E+00	3.25E+00	7.94E-01	2.40E-01			
E-4	1.33E+04	8.40E+01	4.23E+01	1.60E+01	2.92E+00	7.20E-01	4.22E-01	2.87E+00	7.22E-01	2.75E-01
F-1	5.28E+01	2.67E+01	1.90E+00	1.80E+00	1.47E+00	1.17E+00	2.35E-02			
F-2	4.78E+02	3.57E+01	2.10E+00	2.00E+00	2.38E+00	1.25E+00	2.12E-02			
F-3	7.14E+02	3.80E+01	2.20E+00		2.65E+00	1.29E+00	4.14E-02			
F-4	7.69E+02	9.35E+01	5.50E+00	2.00E+00	2.68E+00	1.67E+00	4.39E-01			
F-5	9.52E+02	9.90E+01	1.12E+01	5.20E+00	2.26E+00	1.28E+00	3.33E-01			
F-6	5.96E+03	3.33E+03	2.00E+01	2.60E+01	2.36E+00	2.11E+00	0.00E+00	2.27E+00	1.46E+00	1.43E-01
mean	6.27E+03	2.04E+02	6.68E+01	2.94E+01	2.32E+00	8.13E-01	2.23E-01			
SD	1.03E+04	5.84E+02	1.92E+02	6.53E+01	6.50E-01	5.22E-01	2.53E-01			

SAMPLE NUMBER	fecal coliform Inflow cfu/100mL	fecal coliform Secondary cfu/100mL	fecal coliform Filtered cfu/100mL	fecal coliform Disinfected cfu/100mL	Log removal inflow -> disinfected	Log removal secondary -> disinfected	Log removal filtered -> disinfected	mean Log removal plant-specific inflow -> disinfected	mean Log removal plant-specific secondary -> disinfected	mean Log removal plant-specific filtered -> disinfected
A-1	2.63E+06	2.40E+04	1.20E+00	3.00E-01	6.94E+00	4.90E+00	6.02E-01			
A-2	2.87E+06	2.57E+04	1.30E+00	3.00E-01	6.98E+00	4.93E+00	6.37E-01			
A-3	3.07E+06	2.93E+04	2.04E+02	3.00E-01	7.01E+00	4.99E+00	2.83E+00			
A-4	6.20E+06	6.07E+04	7.30E+02	3.33E-01	7.27E+00	5.26E+00	3.34E+00			
A-5	6.83E+06	2.30E+05	1.13E+03	3.33E-01	7.31E+00	5.84E+00	3.53E+00	7.10E+00	5.19E+00	2.19E+00
B-1	6.15E+05	2.46E+04	3.00E-01	3.00E-01	6.31E+00	4.91E+00	0.00E+00			
B-2	3.20E+05	4.55E+04	3.00E-01	3.00E-01	7.03E+00	5.18E+00	0.00E+00			
B-3	4.10E+06	6.00E+04	3.00E-01	3.00E-01	7.14E+00	5.30E+00	0.00E+00			
B-4	4.30E+06	6.10E+04	3.00E-01	5.00E-01	6.93E+00	5.00E+00	0.00E+00			
B-5	4.30E+06	1.20E+05	7.00E-01	5.00E-01	6.93E+00	5.38E+00	1.46E-01			
B-6	4.86E+06		2.40E+04	7.00E-01	6.84E+00	0.00E+00	4.54E+00			
B-7								6.86E+00	4.31E+00	7.80E-01
C-1	2.00E+06	2.20E+04	1.14E+02	3.00E-01	6.82E+00	4.87E+00	2.58E+00			
C-2	6.83E+06	6.90E+04	2.60E+02	5.00E-01	7.07E+00	5.08E+00	2.72E+00			
C-3	6.40E+06	1.23E+05	3.33E+02	5.00E-01	7.11E+00	5.39E+00	2.82E+00			
C-4	7.13E+06	3.80E+05	5.00E+02	1.00E+00	6.85E+00	5.58E+00	2.70E+00			
C-5	7.90E+06	5.50E+05	2.50E+03							
C-6								6.96E+00	5.23E+00	2.70E+00
C-7										
D-1	2.30E+06	3.00E+01	9.20E+01	3.00E-01	6.88E+00	2.00E+00	2.49E+00			
D-2	2.83E+06	3.33E+01	2.86E+02	3.00E-01	6.97E+00	2.05E+00	2.98E+00			
D-3	2.97E+06	3.33E+03	7.20E+02	3.00E-01	7.00E+00	4.05E+00	3.38E+00			
D-4	2.97E+06	4.87E+03	4.27E+03	4.67E+00	5.80E+00	3.02E+00	2.96E+00			
D-5	4.00E+06	3.18E+04	6.20E+03	3.50E+01	6.96E+00	2.99E+00	2.23E+00			
D-6	5.30E+06	3.53E+04	1.19E+04	2.06E+03	3.41E+00	1.23E+00	7.62E-01			
D-7		4.07E+04	4.33E+04					5.85E+00	2.55E+00	2.47E+00
E-1	7.00E+05	2.30E+03	1.15E+02	6.60E-01	6.03E+00	3.54E+00	2.24E+00			
E-2	9.70E+05	3.70E+04	2.86E+02	1.00E+00	5.99E+00	4.57E+00	2.46E+00			
E-3	2.77E+06	3.87E+04	1.43E+04	3.00E+00	6.97E+00	4.11E+00	3.68E+00			
E-4	9.77E+06	6.67E+04	8.50E+04	9.33E+02	4.02E+00	1.85E+00	1.98E+00	5.50E+00	3.52E+00	2.58E+00
F-1	4.73E+05	3.60E+02	3.00E-01	3.00E-01	6.20E+00	3.08E+00	0.00E+00			
F-2	2.13E+06	7.60E+02	7.00E-01	3.00E-01	6.85E+00	3.40E+00	3.68E-01			
F-3	2.30E+06	3.30E+03	7.06E+01	3.00E-01	6.88E+00	4.04E+00	2.37E+00			
F-4	3.86E+06	5.30E+03	1.41E+02	3.00E-01	7.11E+00	4.25E+00	2.67E+00			
F-5	4.43E+06	7.40E+03	2.34E+02	3.00E-01	7.17E+00	4.39E+00	2.89E+00			
F-6										
F-7								6.84E+00	3.83E+00	1.66E+00
mean	3.87E+06	6.75E+04	6.15E+03	1.02E+02	6.53E+00	4.04E+00	2.00E+00			
SD	2.23E+06	1.18E+05	1.69E+04	4.07E+02	9.26E-01	1.45E+00	1.36E+00			

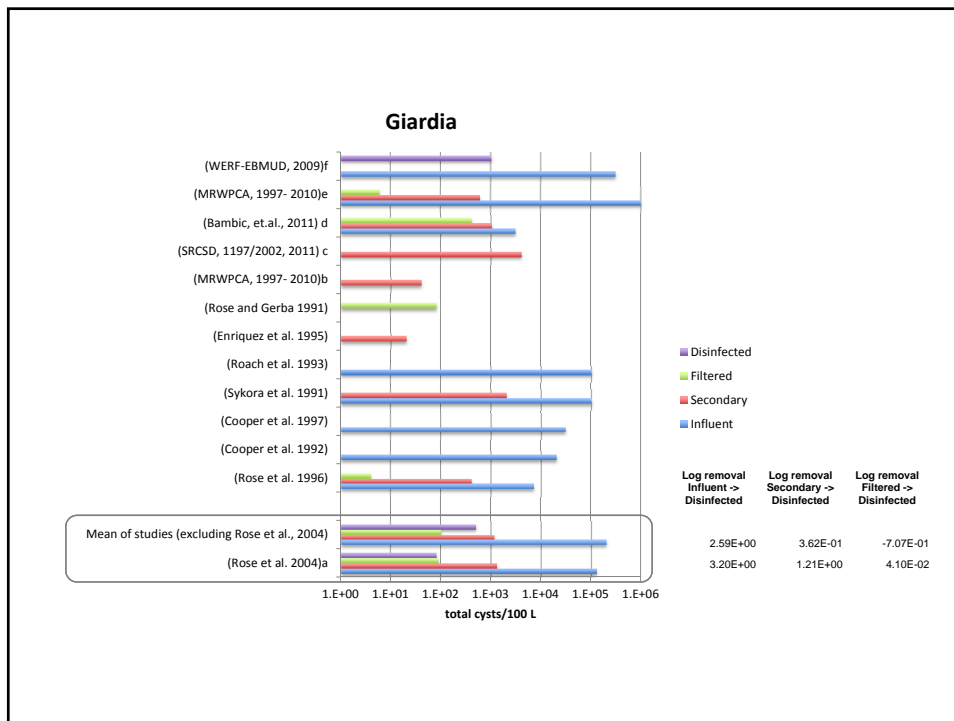
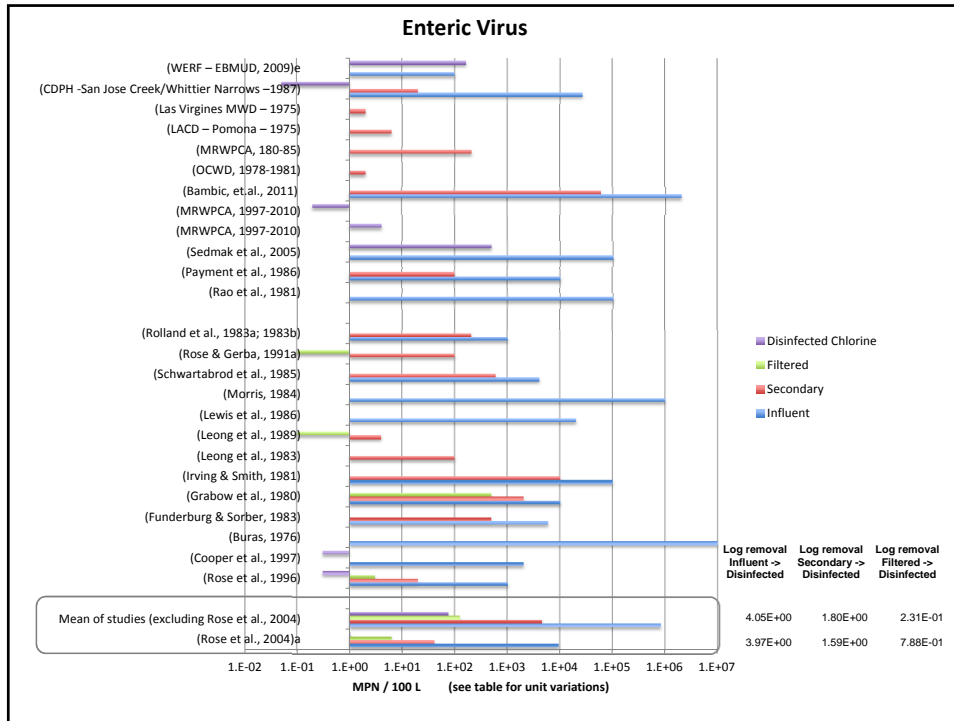

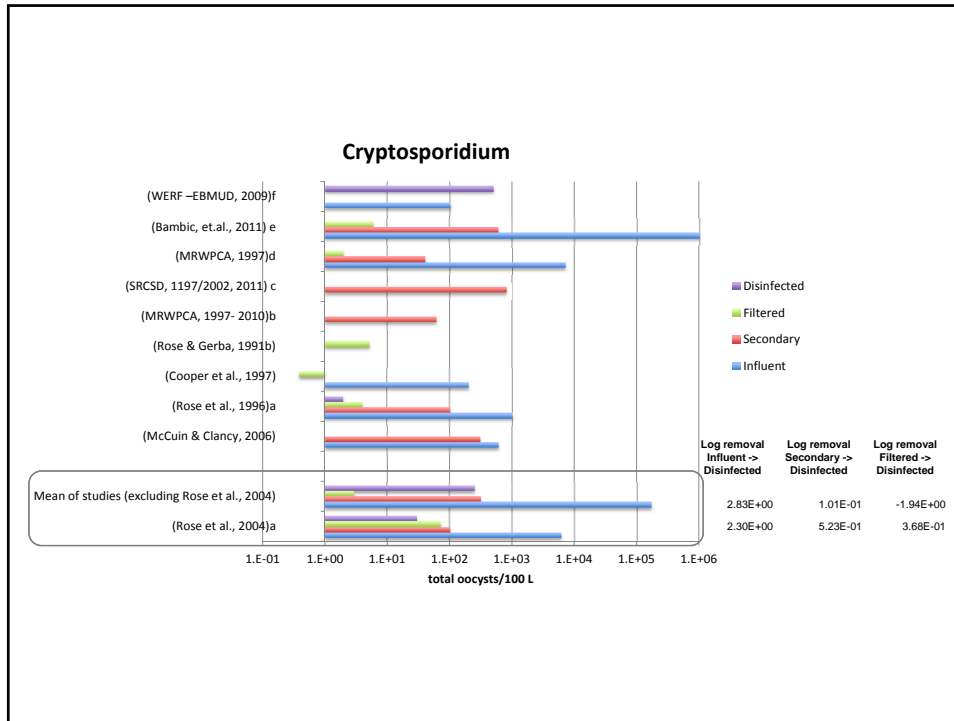

E. Coli 0157:H7

- In previous WRF, we used fecal coliform data from Rose, et al. 2004 to characterize treatment efficacy

	fecal coliform Inflow cfu/100 mL	fecal coliform Secondary cfu/100 mL	fecal coliform Filtered cfu/100 mL	fecal coliform Disinfected cfu/100 mL	Log removal inflow -> disinfected	Log removal secondary -> disinfected	Log removal filtered -> disinfected
mean	3.87E+06	6.75E+04	6.15E+03	1.02E+02	6.53E+00	4.04E+00	2.00E+00
SD	2.23E+06	1.18E+05	1.69E+04	4.07E+02	9.26E-01	1.45E+00	1.36E+00

Literature review of average reported values

Source	Influent 0157 per 100 mL	Assume uniform concentration across the range: 0 – 500 per 100 mL
Heijnen and Medema 2006	0-500	
Muniesa et al 2006	10-100	
Garcia-Alero et al 2006	200	

Adenovirus

(all concentrations shown in parenthesis are virus units/100 L)

Source	Influent	Secondary	Filtered	Disinfected	Log Removal	Comments
La Rossa et.al., 2010	3.3 E+07 (3.3E+12)	NA	None	7.6E+06 (7.6E+11)	0.64 (77%)	GC/mL RT-PCR
Kuo, et.al., 2010	5.5 E+06 (5.5 E +08)	NA	None	5.5 E +03 (5.5 E+05)	3.0 (99.9%)	Virus/L RT-PCR MBR plant
Jacangelo et.al., 2003	NA	NA	None	None	2.24 4.0	Cultured Thru secondary Thru sec. <u>fit.</u> And UV
Carducci, et.al., 2008	NA	NA	None	2.4 E +03 (2.4 E +08)	2.0	GC/mL RT-PCR
Katayama, et.al., 2008	3.2 E +02 (3.2 E+07)	NA	None	7.0 E +00 (7.0 E+05)	1.66 (97.8%)	PCR units/mL Geo Mean
Hewitt et.al., 2011	1.9 E +06 (1.9 E+08) 3.5 E +02 (3.5 E +04)	NA	None	9.1 E +04 (9.1 E +06) 9.5 E +01 (9.5 E +03)	1.3 (94.9%) 0.56 (72%)	RT-PCR GC/L IU/L Cultured
Irving & Smith, 1981	1.4 E +03 (1.4 E +05)	2.5 E +02 (2.5 E+04)	None	3.0 E +02 (3.0 E +04)	0.75 (82%)	IU/L Cultured
Fong et.al., 2009	1.15 E +06 (1.15 E +08)	2.0 E+04 (2.0 E +06)	NA	8.3 E+04 (8.3 E +06)	1.14 (92.7)	Virus/L RT-PCR
EBMUD WERF 2009	11.5 (11.5 E +02)	NA	None	5.5 (5.5 E +02)	0.32 (52%)	MPN/L Cultured
Simmons, et.al., 2011	3.2 E+06 (3.2 E+08)	2.5 E +03 (2.5 E+05)	None	None	3.1 (99.92%)	MBR sec unit RT-PCR Viruses/L
Summary in virus units/100 L	mean	3.67E+11	7.58E+05	None	6.34E+10	1.73E+00
	SD	1.10E+12	1.08E+06	None	2.19E+11	1.17E+00

Adenovirus

(all concentrations shown in parenthesis are virus units/100 L)

Source	Influent	Secondary	Filtered	Disinfected	Log Removal	Comments
La Rossa et.al., 2010	3.3 E+07 (3.3E+12)	NA	None	7.6E+06 (7.6E+11)	0.64 (77%)	GC/mL RT-PCR
Kuo, et.al., 2010	5.5 E+06 (5.5 E +08)	NA	None	5.5 E +03 (5.5 E+05)	3.0 (99.9%)	Virus/L RT-PCR MBR plant
Jacangelo et.al., 2003	NA	NA	None	None	2.24 4.0	Cultured Thru secondary Thru sec. <u>fit.</u> And UV
Carducci, et.al., 2008	NA	NA	None	2.4 E +03 (2.4 E +08)	2.0	GC/mL RT-PCR
Katayama, et.al., 2008	3.2 E +02 (3.2 E+07)	NA	None	7.0 E +00 (7.0 E+05)	1.66 (97.8%)	PCR units/mL Geo Mean
Hewitt et.al., 2011	1.9 E +06 (1.9 E+08) 3.5 E +02 (3.5 E +04)	NA	None	9.1 E +04 (9.1 E +06) 9.5 E +01 (9.5 E +03)	1.3 (94.9%) 0.56 (72%)	RT-PCR GC/L IU/L Cultured
Irving & Smith, 1981	1.4 E +03 (1.4 E +05)	2.5 E +02 (2.5 E+04)	None	3.0 E +02 (3.0 E +04)	0.75 (82%)	IU/L Cultured
Fong et.al., 2009	1.15 E +06 (1.15 E +08)	2.0 E+04 (2.0 E +06)	NA	8.3 E+04 (8.3 E +06)	1.14 (92.7)	Virus/L RT-PCR
EBMUD WERF 2009	11.5 (11.5 E +02)	NA	None	5.5 (5.5 E +02)	0.32 (52%)	MPN/L Cultured
Simmons, et.al., 2011	3.2 E+06 (3.2 E+08)	2.5 E +03 (2.5 E+05)	None	None	3.1 (99.92%)	MBR sec unit RT-PCR Viruses/L
With outlier removed Summary in virus units/100 L	mean	1.51E+08	7.58E+05	None	2.35E+07	1.82E+00
	SD	1.98E+08	1.08E+06	None	7.19E+07	1.17E+00

outlier

Risk Calculations

Static model

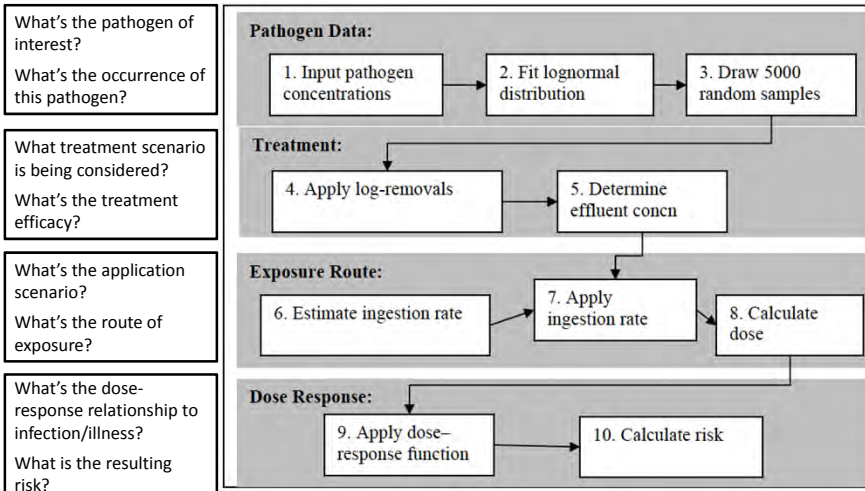

Test: Replicating Tanaka et al., 1998

- Four plants (OCSD_TF, OCSD_AS, Pomona_AS, MRWPCA_AS)
- Log-normal distributions fit to virus concentrations measured at unchlorinated secondary

Parameter	OCSD_TF	OCSD_AS	Pomona_AS	MRWPCA_AS
Mean log ₁₀ C	0.15	-1.47	-3.81	0.37
SD log ₁₀ C	0.63	0.91	2.06	0.86

- Treatment efficacy from Pomona virus study applied:

Treatment	Log removal
Full treatment (filtration and disinfection)	5.2
Chlorination of secondary	4.7

Test: Replicating Tanaka et al., 1998

- Crop irrigation exposure adapted from Asano, et al., 1992
 - Ingestion: 10 ml/exposure event
 - Exposure frequency: everyday
 - Decay assumption: stop irrigation 2 wks before harvest and shipment; viral reduction resulting from sunlight
 - $\exp(-k t)$, where $k=0.69$, $t=14$ days, i.e., decay by 0.00006
- Beta dose response:
 - 2-parameter Beta-Poisson function for Rotavirus:
 - $a = 0.232$, $b = 0.247$ (Rose and Gerba, 1991)
- Estimate annualized risk (i.e., risk of being infected at least once in a year)
- Monte Carlo simulations, $n=500$

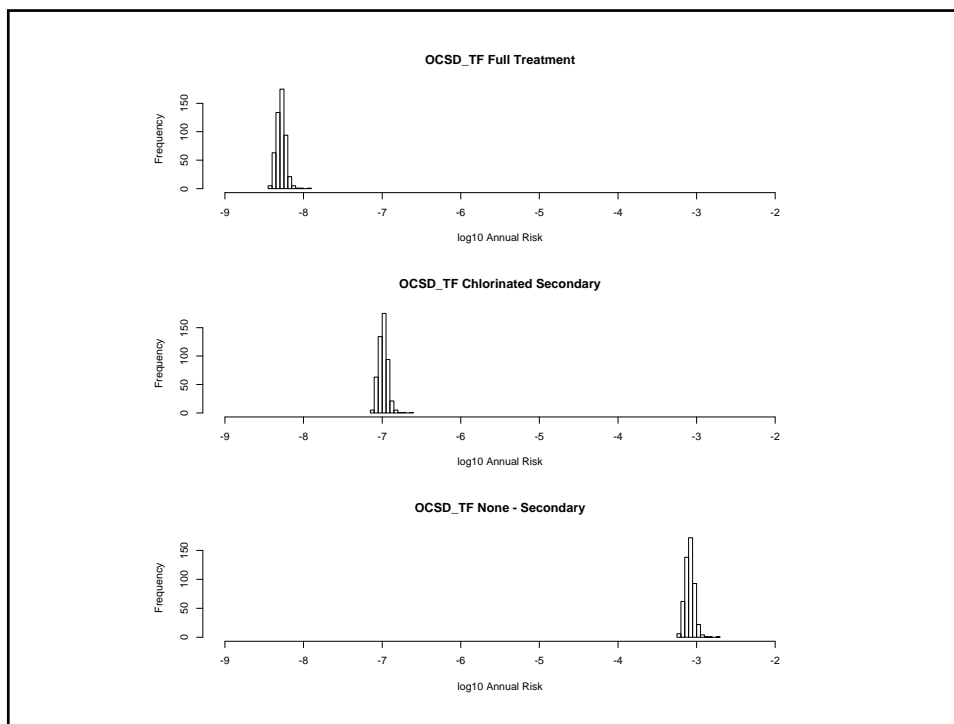

Test: Replicating Tanaka et al., 1998

- Expectations of annualized risk for crop irrigation (means)

Treatment	OCSD_TF	OCSD_AS	Pomona_AS	MRWPCA_AS
Full (5.2 log)	10^{-9}	10^{-10}	10^{-9}	10^{-8}
Chlorination (4.7 log)	10^{-7}	10^{-9}	10^{-8}	10^{-7}
None (0 log)	10^{-4}	10^{-5}	10^{-4}	10^{-3}

We produce essentially the same results as Tanaka, et al using their assumptions.

Our Modeling Assumptions

First exposure scenario: Tertiary treatment, consumption of food crops that come in direct contact with irrigation water, no environmental decay.

- Concentration distribution data from Rose et al., 2004
- Treatment efficacy distribution data derived from Rose et al., 2004
- No environmental decay
- Exposure as parameterized by Hamilton et al., 2006.
 - Consumption rate: (Lettuce) 0.205 g/kg-day (U.S. EPA, 2003)
 - Body mass: lognormal distribution with mean of 61.4 and standard deviation of 13.4 kg (U.S. EPA, 1997)
 - Volume uptake: Zero-truncated normal distribution with mean 0.108 and standard deviation of 0.02 ml/g (Shuval et al., 1997)
- Annualized risk assuming exposure everyday of the year.
- Dose response relationships mentioned at the April, 2011 NWRI Panel Meeting.
- We consider the sensitivity of the risk results to some of the exposure and environmental decay assumptions.

Enteric Virus Input concentrations

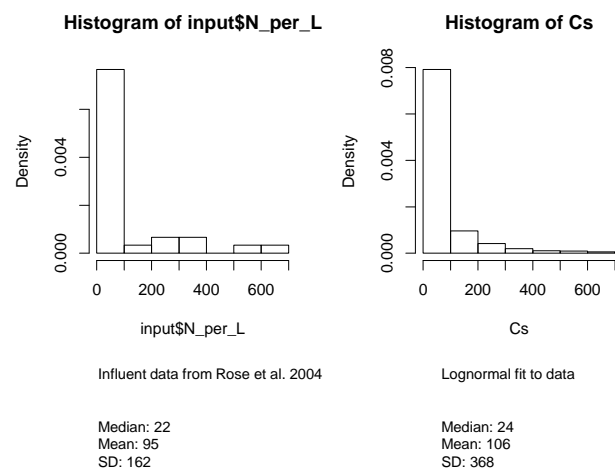

Enteric Virus Treatment efficacy

Histogram of $\log_{10}(\text{Te_influent_disinfected})$

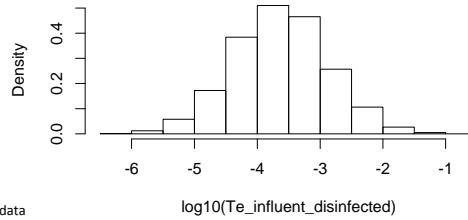

Based on Rose et al, 2004 data

Treatment efficacy from influent through to disinfection

Enteric Virus Concentrations after treatment

Histogram of Cs

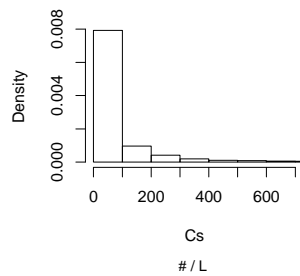

Median: 24
Mean: 106
SD: 368

Histogram of C_disinfected

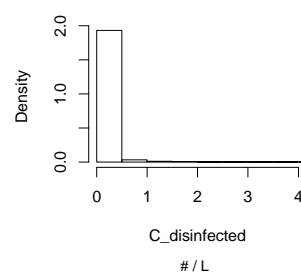

Median: 0.006
Mean: 0.1
SD: 0.8

Enteric Virus Exposure

Histogram of log₁₀(intake)

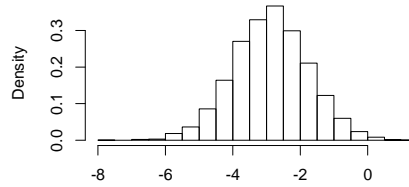

Consumption rate: (Lettuce) 0.205 g/kg-day
(U.S. EPA, 2003)
Body mass: lognormal distribution with mean of
61.4 and standard deviation of 13.4 kg (U.S. EPA, 1997)
Volume uptake: Zero-truncated normal distribution with
mean 0.108 and standard deviation of 0.02 ml/g

Hamilton et al, 2006

log₁₀(intake)
log₁₀(L / day)
Median: 0.001 (L / day)
Mean: 0.03
SD: 0.4

Enteric Virus Dose

Histogram of log₁₀(d)

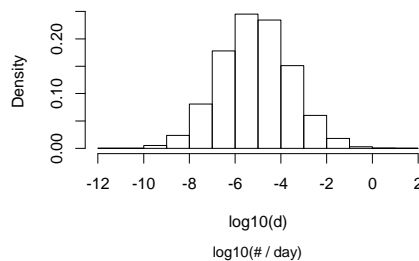

Median: 0.001 (# / day)
Mean: 0.03
SD: 0.4

Dose-response: applied 2-parameter Beta-Poisson
function for Rotavirus: a = 0.167, b = 0.191

Teunis and Havelaar, 2000

Enteric Virus Risk per event

Histogram of $\log_{10}(\text{Pinf})$

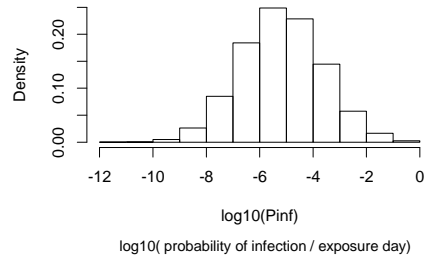

Median: 6.6E-6 (probability of infection / exposure day)
Mean: 1.2E-3
SD: 1.3E-2

Enteric Virus Annualized risk

Recap of scenario 1.

- Tertiary treatment
- No environmental decay
- Consumption of crops that come in direct contact with irrigation water
- Consumption everyday of year

Histogram of $\log_{10}(\text{AnnRisk_enterovirus})$

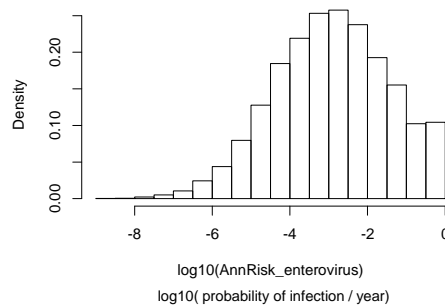

Ingestion (lettuce) everyday of year

Hamilton et al. NSW

Median: 1.3E-3 (probability of infection / year)
Mean: 5.3E-2
SD: 1.7E-1

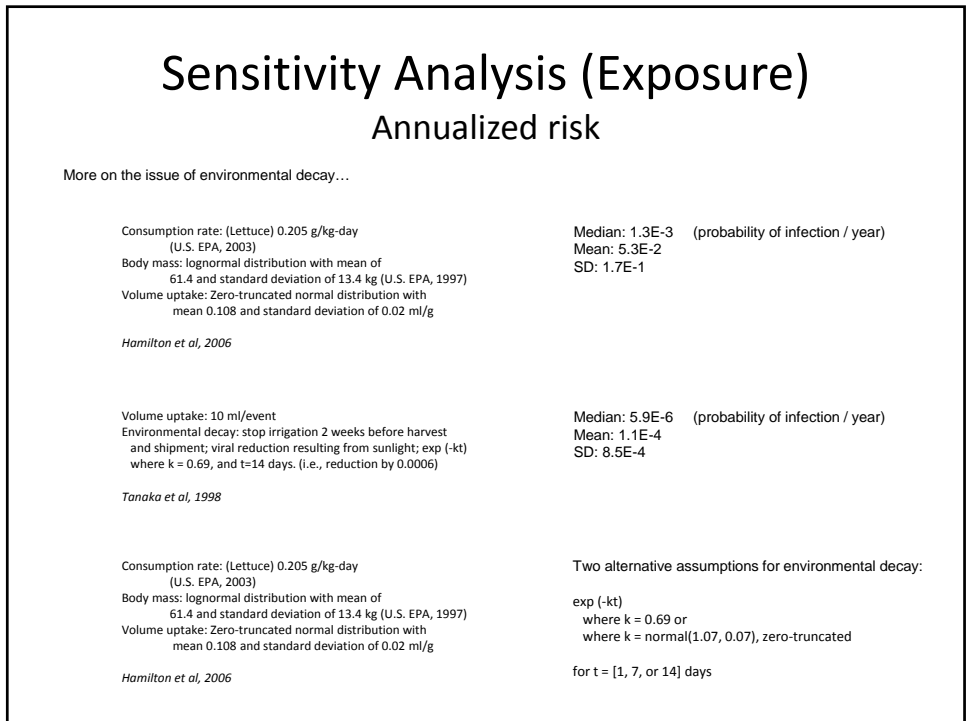
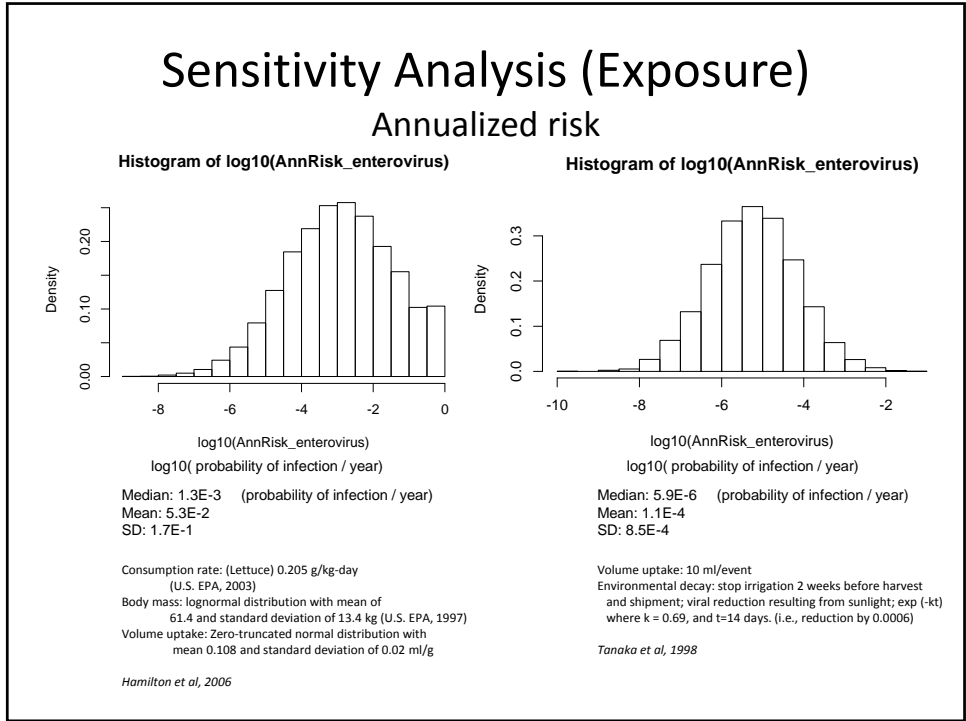

Sensitivity Analysis (Exposure)

Annualized risk

<i>Hamilton et al., with no environmental decay</i>		Median: 1.3E-3 (probability of infection / year)		
		Mean: 5.3E-2		
		SD: 1.7E-1		
			<u>1 day</u>	<u>7 days</u>
				<u>14 days</u>
<i>Hamilton et al., with k=0.69 environmental decay</i>	Median	6.46E-4	1.03E-5	8.21E-8
	Mean	3.71E-2	2.51E-3	4.32E-5
	SD	1.38E-1	3.04E-2	1.40E-3
<i>Hamilton et al., with k=normal(1.07, 0.07), zero-truncated environmental decay</i>	Median	4.35E-4	7.00E-7	4.65E-10
	Mean	2.99E-2	3.68E-4	7.35E-7
	SD	1.23E-1	1.17E-2	4.91E-5

Sensitivity Analysis (Annualized Risk)

(probability of infection / year)

Median: 1.3E-3

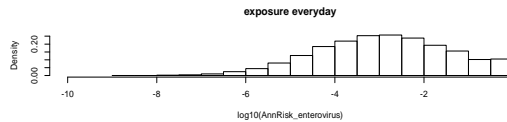

Median: 6.4E-3

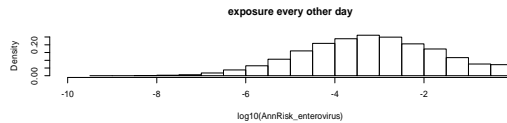

Median: 2.5E-4

Food crop consumption (commercial)
Ingestion (lettuce) 70 times / person / year

Kahn et al. NSW

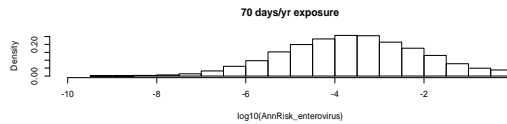

Median: 1.3E-4

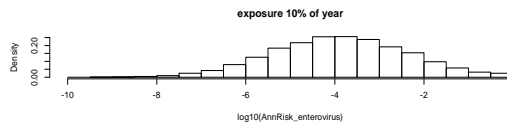

Sensitivity Analysis (Treatment)

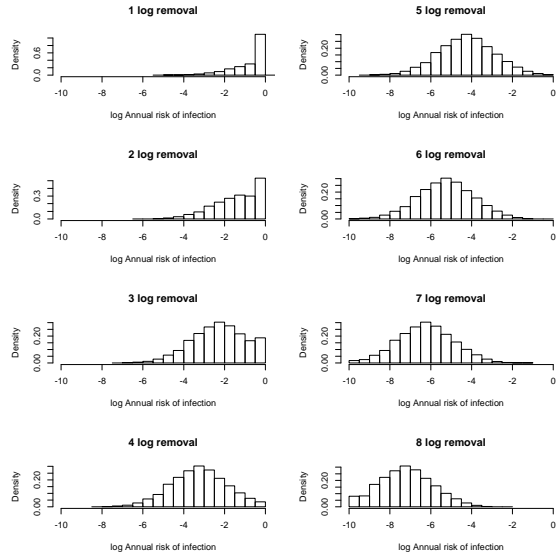

Rose et al., 2004
~4 log

Preliminary Findings

- Scenario 1.**
- Tertiary treatment
 - No environmental decay
 - Consumption of **crops that come in direct contact** with irrigation water
 - Consumption everyday of year

Risk of Infection per Exposure Day

	Enterovirus	Giardia	Cryptosporidium	E. coli 0157
Min	4.67E-12	4.50E-12	2.31E-11	4.77E-15
0.25	3.17E-07	3.77E-07	9.57E-07	3.82E-09
Median	3.53E-06	4.29E-06	1.01E-05	4.19E-08
0.75	3.78E-05	4.79E-05	1.07E-04	4.40E-07
0.9	3.10E-04	3.96E-04	8.34E-04	3.89E-06
0.95	1.16E-03	1.54E-03	2.95E-03	1.31E-05
Max	6.57E-01	1.00E+00	1.00E+00	4.52E-03
Mean	1.00E-03	1.43E-03	2.14E-03	9.20E-06
SD	1.47E-02	2.26E-02	2.79E-02	1.07E-04

Annualized Risk of Infection (exposure everyday)

	Enterovirus	Giardia	Cryptosporidium	E. coli 0157
Min	1.70E-09	1.64E-09	8.44E-09	1.74E-12
0.25	1.16E-04	1.37E-04	3.49E-04	1.40E-06
Median	1.29E-03	1.57E-03	3.67E-03	1.53E-05
0.75	1.37E-02	1.73E-02	3.85E-02	1.60E-04
0.9	1.07E-01	1.35E-01	2.62E-01	1.42E-03
0.95	3.44E-01	4.30E-01	6.60E-01	4.76E-03
Max	1.00E+00	1.00E+00	1.00E+00	8.09E-01
Mean	5.37E-02	6.13E-02	8.71E-02	2.78E-03
SD	1.69E-01	1.82E-01	2.16E-01	2.63E-02

Summary

- The Rose et al., 2004 data seem consistent with other studies.
- Using our simulations, we replicate Tanaka et al., 1998 with their assumptions
- Using our assumptions, preliminary QMRA results were median risks of infection between 10^{-5} and 10^{-8} *per exposure event*.
- Median annualized risks of infection were between 10^{-5} to 10^{-3} .
- Using enteric virus and consumption of crop that comes into direct contact with irrigation water as a case study, sensitivity analyses of median annual risk show:
 - Medium sensitivity to exposure assumptions (~2 log)
 - Large sensitivity to environmental decay assumptions (~4-6 logs)
 - Small sensitivity to exposure frequency assumptions (~1 log)
 - Medium sensitivity to treatment assumptions (~1 log risk per 1 log removal)

Preliminary Findings

Scenario 2.

- Secondary undisinfected treatment
- No environmental decay
- Consumption of crop from **orchards and vineyards** where water does not come in direct contact with edible crop
- Consumption everyday of year

Volume ingested:
0.1 ml/event

Exposure frequency:
everyday

Annualized Risk of Infection (exposure everyday)

	Enterovirus	Giardia	Cryptosporidium	E. coli 0157
Min	7.18E-07	2.77E-08	1.59E-07	2.02E-08
0.25	4.97E-04	1.88E-04	3.38E-04	4.22E-03
Median	1.89E-03	1.14E-03	1.65E-03	1.99E-02
0.75	7.10E-03	6.58E-03	7.65E-03	8.52E-02
0.9	2.26E-02	3.12E-02	2.97E-02	2.87E-01
0.95	4.77E-02	7.93E-02	6.99E-02	5.53E-01
Max	8.59E-01	1.00E+00	1.00E+00	1.00E+00
Mean	1.11E-02	1.92E-02	1.61E-02	9.77E-02
SD	3.82E-02	7.82E-02	6.05E-02	1.92E-01

Preliminary Findings

Scenario 3.

- Secondary disinfected treatment
- No environmental decay
- Consumption of crop, where edible portion of **crop is above ground (no contact with water)**
- Consumption everyday of year

Volume ingested:
0.1 ml/event

Exposure frequency:
everyday

Annualized Risk of Infection (exposure everyday)

	Enterovirus	Giardia	Cryptosporidium	E. coli O157
Min	3.38E-08	2.52E-08	6.38E-08	8.51E-13
0.25	9.35E-05	1.41E-04	1.99E-04	1.42E-05
Median	4.75E-04	8.32E-04	1.05E-03	2.24E-04
0.75	2.29E-03	4.60E-03	5.17E-03	3.01E-03
0.9	9.19E-03	2.07E-02	2.21E-02	3.34E-02
0.95	2.21E-02	5.37E-02	5.25E-02	1.46E-01
Max	9.45E-01	1.00E+00	1.00E+00	1.00E+00
Mean	6.05E-03	1.36E-02	1.32E-02	3.18E-02
SD	3.08E-02	6.08E-02	5.55E-02	1.33E-01

Adenovirus challenges

- Dose response relationship is based on Couch, 1966 *inhalation* study.
- All our current exposure assumptions are based on an ingestion route.

Adenovirus results

Scenario 1.

- Tertiary treatment
- No environmental decay
- Consumption of crops that come in direct contact with irrigation water
- Consumption everyday of year

Using inhalation dose
Response relationship

Risk of Infection per Exposure Day

Adenovirus	
Min	4.52E-11
0.25	3.88E-03
Median	2.42E-01
0.75	1.00E+00
0.9	1.00E+00
0.95	1.00E+00
Max	1.00E+00
Mean	4.56E-01
SD	4.54E-01

Annualized Risk of Infection (exposure everyday)

Adenovirus	
Min	1.65E-08
0.25	7.58E-01
Median	1.00E+00
0.75	1.00E+00
0.9	1.00E+00
0.95	1.00E+00
Max	1.00E+00
Mean	7.89E-01
SD	3.70E-01

Additional Challenge: Adenovirus Harmonization

From Bambic et al., 2011 WERF PATH2R08 QMRA rec water...

"The form of the "dose" used in a clinical trial needs to be made consistent with the form used to describe the dose ingested or inhaled... This important topic is called **harmonization**...

For Adenovirus

Trial by Couch et al., 1966 based on TCID₅₀ viral particulates for Adenovirus 4 inhaled via aerosols

WERF study lab methods by qPCR

Harmonization rule:

Genome/PFU ~ 1000 (raw primary effluent) (He and Jiang, 2005)
1 TCID₅₀ ~ 0.7 PFU (Dulbecco, 1988)

Hence: 1 TCID₅₀ = 700 genomes

Adenovirus Harmonization

Annualized Risk of Infection (exposure everyday)

	Adenovirus	Adenovirus (with harmonization)
Median	1.00E+00	1.35E-01
Mean	7.89E-01	4.17E-01
SD	3.70E-01	4.49E-01

Questions

- Are the assumptions used for consumption on the three treatment and reuse options reasonable?
- Is the assumption regarding no environmental decay after tertiary treatment reasonable?
- Are the assumptions reasonable for adenovirus?

Q 2 Acceptable Risk

- Definition and Regulatory Examples
- DPH Historical Background Information & Assumptions
- MRA Recycled Water Examples
- Comparison to diarrheal disease incidence
- Overall Conclusions

Acceptable Risk – Q2

- Acceptable risk can be defined as the level of risk that is protective of public health for a population considering cost, feasibility, and other considerations.
- WHO recommends “tolerable” risk which can be borne by a particular community and have placed an emphasis incorporating concept of adjusting life years based on disability (i.e., considering severity and duration of a disease/infection allows shifting from parasites to viruses as the waterborne pathogen of concern).

Several Examples

- Surface Water Treatment Rule – one infection per 10,000 people per year (or 0.0001 pppy) as a reasonable and acceptable health goal.
- Ambient Water Quality Criteria in recreational waters are set to limit the rate of highly credible gastrointestinal illness in swimmers to no more than 8 per 1,000 recreators (or 0.008 pppy) in freshwater and 19 per 1000 in marine waters (or 0.019 pppy)

Examples (Cont’d)

- WHO (2004) defined the “tolerable” risk of disease for fully treated drinking water to be 1 per 1,000 (or 0.1% of disease in the community per year).
- Some public health experts have indicated that a more “acceptable” level of risk should be based on infection and would be on the order of 1 per 100 (or 1% of the community infected per year)

Brief Review the Historical DPH Record (DPH, 1991, DPH 1987)

- Acceptable incidence of symptoms for diarrhea, fever etc. for persons exposed to recycled water is 4 per 100,000 (this could be as low as 1 per 100,000 depending on the symptom or disease);
- Assumed a probability of infection associated with the above symptoms is on the order of 1 per 1000 (based on a ratio of disease to infection of 1 to 100 (Pipes, 1978)).

DPH Background

- The estimated and acceptable risk of infection for swimming in receiving waters where secondary treated disinfected wastewater is discharged (fecal coliform <23 MPN/100mL) and 100ml of water is consumed is on the order of 2/1000 for *Giardia lamblia* and 8/100,000 for enteroviruses (Polio I) and results in reducing the U.S. EPA acceptable risk of illness for recreation by roughly 50%.

DPH – Title 22 Assumptions

- DPH implementation of Title 22 is based on a goal that the treatment based standards provide sufficient overall plant reliability to achieve the U.S. EPA SWTR acceptable risk goal of one infection per 10,000 people per year based on enteric viruses

MRA Results – Recycled Water

- Tanaka et.al. - estimated annual risk of infection for full treatment (i.e., secondary plus filtration per Title 22), contact filtration (i.e., direct filtration) and for secondary treatment and high chlorine dose are less than 1 per 10,000 even at a 95% CL.

MRA - Results

- WRF (Olivieri & Seto) – daily risk of infection
- a median of 3.1 to 3.9 per 100,000 (disinfected secondary) to 1 per 100,000 to 4.5 per 1,000,000 (disinfected tertiary) for parasites (i.e., *Giardia* and *Cryptosporidium spp.*); and
- a median of 1.7 per 100,000 (disinfected secondary) to 3.9 per 1,000,000 for enteric viruses.

Comparison to diarrheal disease incidence

- Estimated diarrheal disease incidence in developed countries is on the order of 0.2 to 0.75 per person per year
- 0.2 to 0.75 per person per year (pppy) disease incidence (assuming that the ratio of infection/disease is 1) vs current examples of “acceptable” levels indicates that those levels are several (at least 2) orders of magnitude lower than the diarrheal disease incidence

Overall Conclusions

- No need for DPH to develop an “acceptable” or “tolerable” risk metric for Title 22 reuse applications (de minimus risk)
- Review of the available weight of evidence confirms that the current Ag practices done consistent with Title 22 do not increase public health risk
- Tightening the Title 22 standards will not improve public health

CT (450 mg-min/L)

- **Based on 1976 Pomona Virus Study**
 - Wastewater not nitrified
 - Disinfection with combined chlorine
 - Seeded poliovirus
 - 90-minute contact time
 - Used combined chlorine residuals of 5 & 10 mg/L
 - Also evaluated free chlorine residual of 4 mg/L
- **Required CT should be based on form of chlorine :combined or free**

Pomona Virus Study

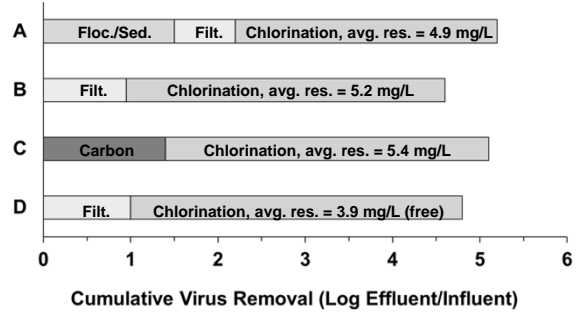

Pomona Virus Study

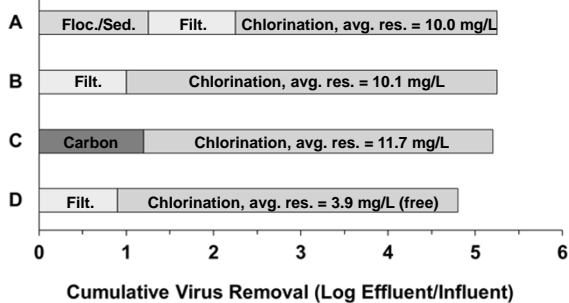

CT

- **Lower CT is warranted for disinfection of ammonia-free effluent**
 - Nitrify effluent or use breakpoint chlorination
- **Inappropriate to use drinking water CT criteria**
 - Recycled water more complex than drinking water
 - Thus, need safety factor
- **Until (or unless) the Water Recycling Criteria are changed, CDPH can address this through Section 60320.5 (Other Methods of Treatment)**

Multiple Barriers

- Main concern is pathogens
- Primary, secondary, and tertiary (with media filtration) treatment can reduce the concentration of some of the pathogens
 - But do they truly qualify as meaningful barriers?
- Disinfection is main process for disinfection
 - Disinfection failure = microbial limits not met
 - Thus, emphasis should be placed on efficacy and reliability of disinfection process

Turbidity

- Current turbidity requirement (≤ 2 NTU) is a valid performance standard
 - Readily achievable with conventional technology
 - Needed to ensure effective disinfection via Cl_2 or UV
- Rationale for requiring ≤ 0.2 NTU if membranes are used needs clarification
 - We understand that a well-operated membrane process will meet that requirement
- If membranes are used, CT or UV requirements should be modified to take into account better water quality subject to disinfection

Turbidity

- Turbidity is an indicator of stabilization treatment and a measurement of material that can interfere with disinfection
- Turbidity should be maintained as a compliance measurement unless a more sophisticated approach to quantifying particulate matter is considered
 - Use of particle counts is one approach that could be evaluated

Oxidized Wastewater

- Implies that only biological secondary treatment is acceptable
 - Physical/chemical treatment processes could replace biological treatment and still meet the requirements (organic matter is stabilized and wastewater is nonputrescible and contains dissolved oxygen)
 - Change “oxidized wastewater” to “stabilized wastewater” and include numerical limits, e.g., EPA’s definition of secondary treatment:
 - 30 mg/L BOD and 30 mg/L TSS; pH in 6-9 range
 - At least 85 percent BOD and TSS removal

Other Methods of Treatment

- **Section 60320.5 of Water Recycling Criteria**
 - **Methods of treatment other than those included in this chapter and their reliability features may be accepted if the applicant demonstrates to the satisfaction of the State Department of Health that the methods of treatment and reliability features will assure an equal degree of treatment and reliability**
- **Can be used to assess other treatment processes and related requirements (e.g., CT, turbidity, etc.)**
- **Is it time for another Pomona-type virus study?**

Question #8

Are total coliforms still an appropriate indicator of overall disinfection performance in the treatment of wastewater to be used on food crops?

A succinct answer: Yes

- The use of coliforms as indicators of the sanitary quality of water has had a successful history for more than a century with particular application to monitoring drinking water.
- In the wastewater reuse arena the public health experience, especially in protecting recreationists in direct contact with reclaimed water, has been positive.
- The use of reclaimed water for unrestricted food crop irrigation has less of a history but experience to date has also been positive.

Experience

- The ability of a treatment plant to consistently produce water that meets total coliform standards has been a key to protection of the public health.
- Total coliforms are the most conservative indicator of plant performance followed by fecal coliforms and *E. coli* in that order

Alternatives

At this point in time we have no practical and time proven alternative to the coliform standard.

Sub sets of the total coliform group have been suggested as being more indicative of sanitary quality, i.e. fecal coliform and *Esherichia coli* for which recognized assay methods are available

Alternatives

- The development of new indicator assays based on molecular biological methods are in the wings but thus far are not practical for routine monitoring or shown to be superior to the coliform standard.

SUPPORT TEXT WILL INCLUDE

- Brief Coliform use history
- Relationship of coliforms to disease agents
- Coliforms and enteric virus in wastewater
- Title 22 coliform requirement and virus reduction: The Pomona Study
- Coliforms as indicators of treatment success in reducing: Bacteria, viruses and protozoan parasites

APPENDIX 2-1: SUMMARY OF CALIFORNIA WATER RECLYING REGULATIONS AND STATUTES

The following is a more detailed discussion the key California regulations (i.e., current and draft), criteria, and policy that impact water recycling projects (groundwater recharge is not included).

Summary of California Enabling Legislation for Recycling Schemes

- Porter-Cologne Water Quality Control Act of the California Water Code (CWC) - The Porter-Cologne Act of the CWC is the statute that gives authority and responsibility to the Regional Water Quality Control Boards (RWBs) to establish water quality objectives, prescribe and enforce requirements for waste discharge to protect surface and groundwater quality, and – in consultation with the California Department of Public Health (CDPH) – prescribe and enforce reclamation requirements. Under the CWC, Waste Discharge Requirements (WDRs) are issued by the RWBs that contain the water quality objectives, effluent limits, and other requirements that are used to regulate reclamation projects. The State has a policy to promote the use of recycled water to the maximum extent to supplement existing surface and ground water supplies to help meet water needs (CWC sections 13510-13512). One of the primary conditions on the use of recycled water is the protection of public health (CWC sections 13521, 13522, 13550(a)(3)). In addition, the 1977 amendments to the federal Clean Water Act (CWA) required publicly owned treatment works (POTWs) to ensure compliance with the pretreatment standards by each significant local source introducing pollutants subject to pretreatment standards into a POTW. To meet the requirements of the 1977 amendments, the U.S. EPA developed the General Pretreatment Regulations for Existing and New Sources of Pollution.
- SWB Recycled Water Policy - The State Water Resources Control Board (SWB) adopted an updated Recycled Water Policy (Resolution No. 2009-0011) in February 2009. The goal of the Policy is to increase the use of recycled water while protecting groundwater quality. The Policy states that local water and wastewater entities, together with salt/nutrient contributing stakeholders, will fund locally driven and controlled collaborative processes open to all stakeholders to develop salt/nutrient management plans for each groundwater basin /sub-basin in California. The policy also attempts to incorporate the most current state-of-the-science on chemicals of emerging concern (CECs) into regulatory policies for use by various state agencies. As a part of this policy, the Southern California Coastal Water Research Project (SCCWRP) was asked to convene a Science Advisory Panel of six experts to provide recommendations to the SWB. The plan development processes must include compliance with California Environmental Quality Act (CEQA) and participation by the RWB staff. Each plan's complexity depends on a variety of site-specific factors, including (but not limited to) the size and complexity of the basin, source water quality, stormwater recharge, hydrogeology, and aquifer water quality. The policy recommends that priority be given to those basins identified as priority basins by the Groundwater Ambient Monitoring Assessment (GAMA) program.

- SWB Nondegradation Policy - In 1968, the SWB adopted Resolution No. 68-16, entitled “Statement of Policy with Respect to Maintaining High Quality Waters in California.” This policy requires the continued maintenance of existing high quality waters and provides conditions under which a change in water quality is allowable. A change must be consistent with maximum benefit to the people of the State, not unreasonably affect present and anticipated beneficial uses of water, and not result in water quality less than that prescribed in water quality control plans or policies.
- RWB Basin Plans - The CWC requires all RWBs to develop, adopt, and implement a Water Quality Control Plan (Basin Plan). The Basin Plan includes three basic components: waters of the State and associated beneficial uses (potential and existing); water quality objectives necessary to protect the uses; and an implementation plan and time schedule for achieving the water quality objectives. Some of the RWBs have specific water recycling guidance and/or implementation criteria designed to enhance the feasibility of water recycling projects (e.g., relax surface and groundwater quality objectives based on technical reports demonstrating that the revised objectives would still protect existing beneficial uses fully while minimizing the need for unnecessary treatment; and streamflow augmentation to enhance or add riparian habitat and/or fisheries beneficial uses by relying on streambeds for transporting and/or recharging recycled water).

California Department of Public Health

The RWBs must consult with and consider recommendations of CDPH when issuing waste discharge/water recycling requirements (CWC section 13523). The statute requires CDPH is to establish uniform statewide recycling criteria for the various uses of recycled water to assure protection of public health where recycled water use is involved (CWC section 13521). CDPH has promulgated regulatory criteria in Title 22, Division 4, Chapter 3, section 60301 et seq. of the CCR. CDPH regulatory criteria include specified approved uses of recycled water, numerical limitations and requirements, treatment method requirements, and performance standards. CDPH regulations allow the use of alternate methods of treatment in some cases, so long as the alternate methods are determined by CDPH to provide equivalent treatment and reliability.

A 1996 Memorandum of Agreement (MOA) between CDPH, SWB, and the RWBs on the use of recycled water allocates primary areas of responsibility and authority between these agencies. The MOA provides methods and mechanisms necessary to assure ongoing and continuous future coordination of activities relative to the use of recycled water in California.

To protect public drinking water supplies, CDPH also has regulations to prevent cross connections between recycled water systems and potable water systems. Local health departments and CDPH have enforcement authority over these cross connection prevention regulations. The California Building Standards Commission sets plumbing standards for use of recycled water in buildings and industries. A summary of key regulations is provided below.

- California Code of Regulations (CCR), Title 22 - The CWC requires CDPH to establish statewide reclamation and public health criteria for each type of recycled water use (Section 13521). CDPH Wastewater Reclamation Criteria are contained in Title 22, Division 4 of the CCR. A summary of the Title 22 criteria is presented in Table 2.1 of Section 2.2 of this report. Title 22 criteria cover three basic areas: standards for bacterial quality, levels and types of treatment required for a specific recycled water use, and standards for reliability of the reclamation plant. CDPH is responsible for the review of all proposed reclamation projects and discharge permits for consistency with Title 22 criteria. In addition, although the quality of recycled water can be produced at a level that is acceptable for full body contact activities and the irrigation of food crops, a number of additional precautions are also implemented to protect public health. For example:

- Recycled water pipes are colored purple and appropriately marked.
- Exposed air vents and appurtenances are labeled.
- Sprinkler heads and valves are marked indicating recycled water.
- Hose bibs are generally made inaccessible to the public.
- Irrigation times are adjusted and overspray minimized to reduce public contact.
- Signage and postings are provided to notify the public.
- Back-flow prevention devices and (where necessary) air-gaps are provided to protect potable water.
- Cross-connection inspections are conducted to protect potable water supplies.

APPENDIX 3-1: SUMMARY OF BAR GRAPHS FOR PATHOGEN LITERATURE REVIEW

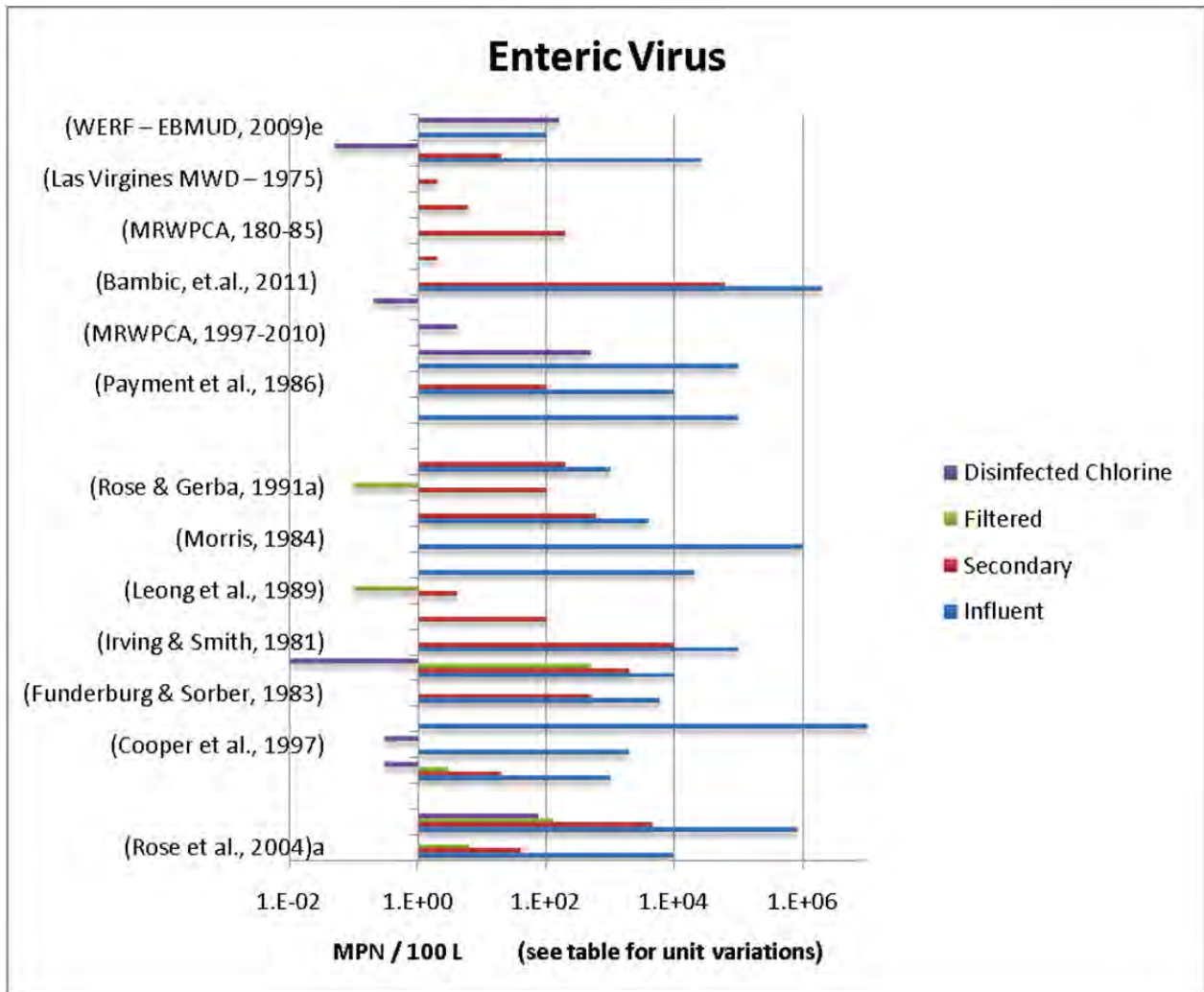

Giardia

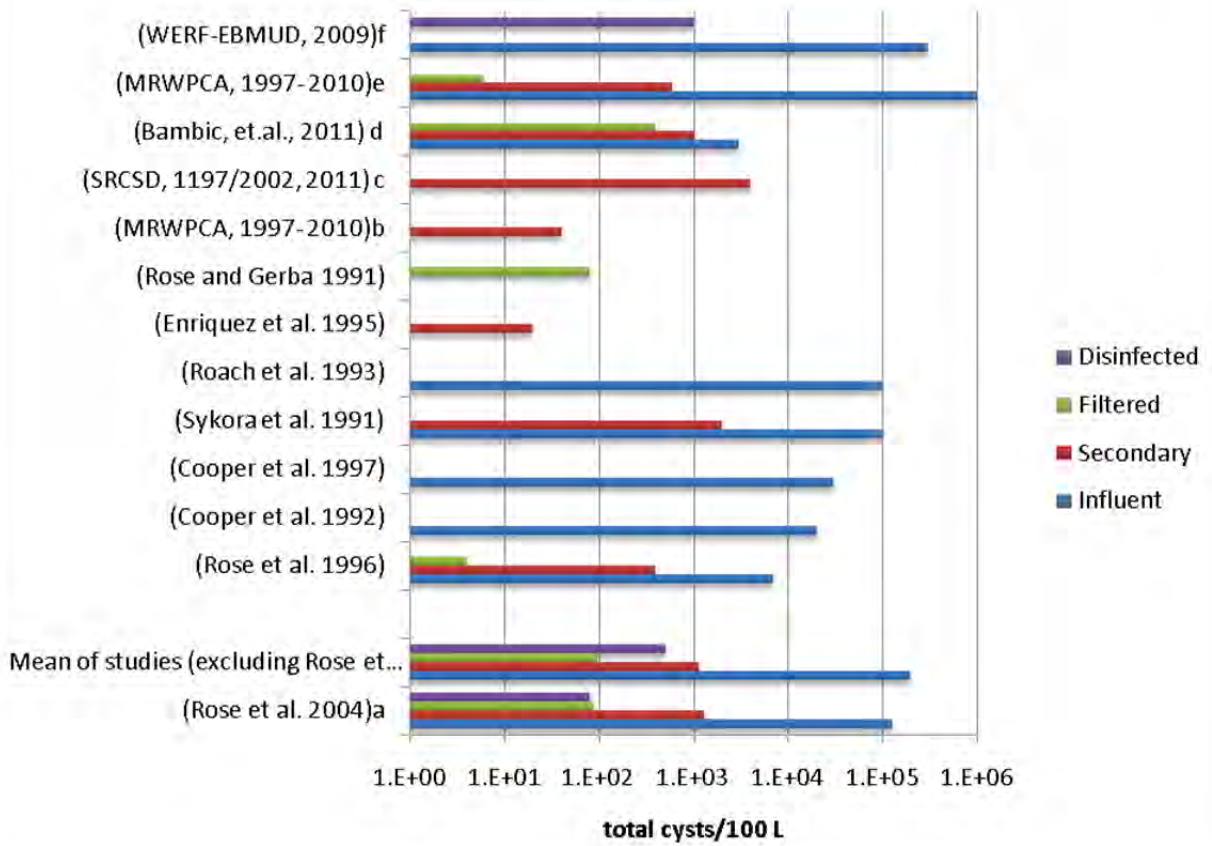

Cryptosporidium

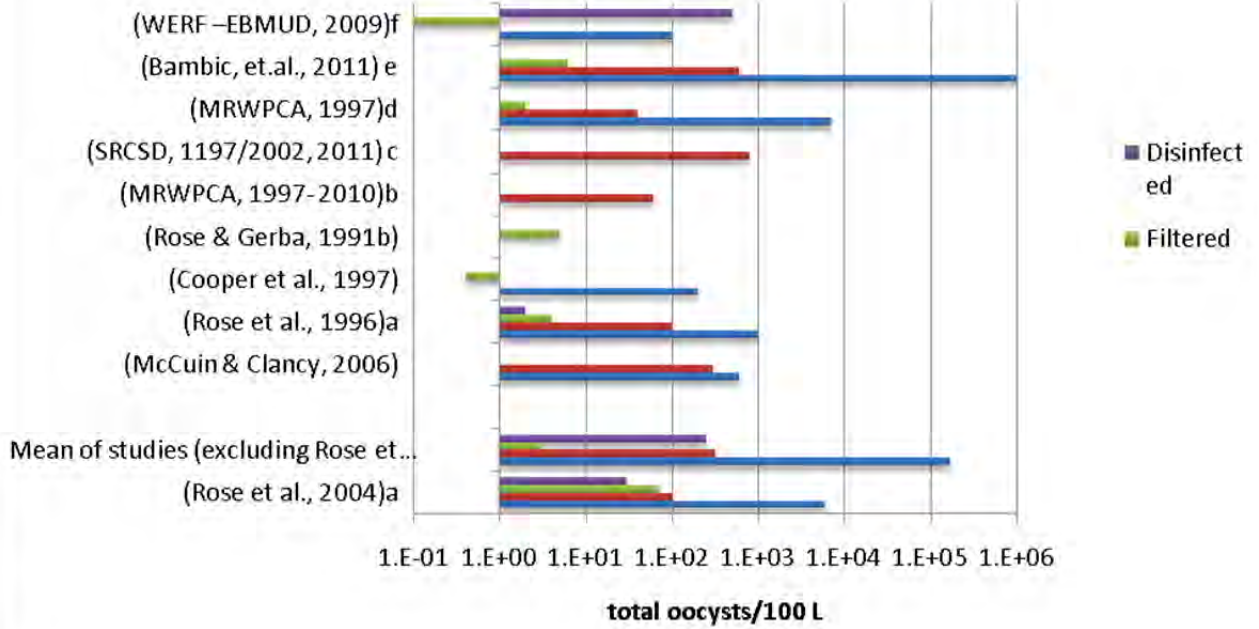

APPENDIX 3-2: EXAMPLE PER EVENT RISK ESTIMATES FOR SCENARIO I

As an example, the following are risk estimates based on single “per event” exposures for Scenario I and are approximately two orders less than annualized estimates.

	Enterovirus	<i>Giardia</i>	<i>Cryptosporidium</i>	<i>E. coli</i> 0157
Min.	0	3.27×10^{-13}	1.57×10^{-12}	0
0.25	1.72×10^{-10}	2.08×10^{-8}	5.17×10^{-8}	2.14×10^{-11}
Median	1.92×10^{-9}	2.34×10^{-7}	5.59×10^{-7}	2.31×10^{-10}
0.75	2.10×10^{-8}	2.63×10^{-6}	5.85×10^{-6}	2.59×10^{-9}
0.9	1.83×10^{-7}	2.35×10^{-5}	4.69×10^{-5}	2.21×10^{-8}
0.95	6.66×10^{-7}	8.87×10^{-5}	1.70×10^{-4}	8.10×10^{-8}
Max.	8.64×10^{-3}	8.48×10^{-1}	9.38×10^{-1}	2.97×10^{-5}
Mean	1.69×10^{-6}	1.91×10^{-4}	2.62×10^{-4}	5.52×10^{-8}
SD	8.96×10^{-5}	8.94×10^{-3}	1.02×10^{-2}	6.53×10^{-7}

**APPENDIX 3-3: SUMMARY STATISTICS FOR RISK DISTRIBUTIONS FOR
TABLES 3-7, 3-8, AND 3-9**

To provide a better understanding of the distribution of uncertainty on the risk estimates, the results of the static assessment method are presented below through a series of statistical tables (see Tables 3-7 to 3-9) that contain the minimum, maximum, mean, and standard deviation (SD) of risk estimate from the Monte Carlo simulations. Additionally, the 25th, 50th (median), 75th, 90th, and 95th percentiles of the risk estimate are also shown in Appendix 3-3.

For example, exposures at the 75th percentile for *Cryptosporidium* would result in 75 percent of all exposed individuals having an annualized risk of infection at or below a 2 in a 1,000 risk level.

**Table 3.7 Scenario I. Tertiary Treatment Applied Directly to Crops.
Summary of Annualized Risks of Infection Assuming All Exposures in the Year
Are to Crops Irrigated with Recycled Water (1.3 mL/day)**

Statistic¹	Enterovirus	Giardia	Cryptosporidium	E. coli O157
Min	0	1.19x10 ⁻¹⁰	5.75x10 ⁻¹⁰	0
0.25	6.28x10 ⁻⁸	7.60x10 ⁻⁶	1.89x10 ⁻⁵	7.82x10 ⁻⁹
Median	7.00x10 ⁻⁷	8.54x10 ⁻⁵	2.04x10 ⁻⁴	8.45x10 ⁻⁸
0.75	7.66x10 ⁻⁶	9.59x10 ⁻⁴	2.13x10 ⁻³	9.46x10 ⁻⁷
0.9	6.66x10 ⁻⁵	8.52x10 ⁻³	1.70x10 ⁻²	8.07x10 ⁻⁶
0.95	2.43x10 ⁻⁴	3.19x10 ⁻²	6.03x10 ⁻²	2.96x10 ⁻⁵
Max	9.58x10 ⁻¹	1.00	1.00	1.08x10 ⁻²
Mean	3.68x10 ⁻⁴	1.21x10 ⁻²	1.82x10 ⁻²	2.01x10 ⁻⁵
SD	1.17x10 ⁻²	7.34x10 ⁻²	9.22x10 ⁻²	2.38x10 ⁻⁴

¹ The descriptive statistics are used to summarize the set of risk estimates to communicate the largest amount of information as simply as possible. For example, statisticians commonly try to describe the observations as follows:

- A measure of location, or central tendency, such as the arithmetic mean, median, and mode.
- A measure of statistical dispersion like the standard deviation, variance, and interquartile range.
- A measure of the shape of the distribution like skewness or kurtosis.

A percentile is the value of a variable below which a certain percent of observations fall. For example, the 25th percentile is the value (or score) below which 25 percent of the observations may be found. The 25th percentile is also known as the first quartile (Q_1), the 50th percentile as the median or second quartile (Q_2), and the 75th percentile as the third quartile (Q_3).

Table 3.8 Scenario II. Secondary Undisinfected Effluent, Not Directly Applied to Edible Portion of Crop. Summary of Annualized Risks of Infection Assuming All Exposures in the Year Are to Crops Irrigated with Reclaimed Water (0.1 mL/day)

Statistic	Enterovirus	<i>Giardia</i>	<i>Cryptosporidium</i>	<i>E. coli O157</i>
Min	3.10×10^{-10}	1.20×10^{-9}	9.67×10^{-9}	1.60×10^{-10}
0.25	2.67×10^{-7}	1.02×10^{-5}	1.84×10^{-5}	2.21×10^{-5}
Median	1.08×10^{-6}	6.49×10^{-5}	9.15×10^{-5}	1.08×10^{-4}
0.75	4.19×10^{-6}	3.86×10^{-4}	4.53×10^{-4}	5.05×10^{-4}
0.9	1.37×10^{-5}	1.87×10^{-3}	1.80×10^{-3}	2.08×10^{-3}
0.95	3.00×10^{-5}	5.05×10^{-3}	4.20×10^{-3}	5.02×10^{-3}
Max	1.36×10^{-3}	7.36×10^{-1}	3.25×10^{-1}	6.34×10^{-1}
Mean	7.58×10^{-6}	1.72×10^{-3}	1.22×10^{-3}	1.38×10^{-3}
SD	3.39×10^{-5}	1.36×10^{-2}	7.23×10^{-3}	9.10×10^{-3}

Table 3.9 Scenario III. Secondary Disinfected, Not Directly Applied to Edible Portion of Crop. Summary of Annualized Risks of Infection Assuming All Exposures in the Year Are to Crops Irrigated with Reclaimed Water (0.1 mL/day)

Statistic	Enterovirus	<i>Giardia</i>	<i>Cryptosporidium</i>	<i>E. coli O157</i>
Min	0	1.09×10^{-9}	3.87×10^{-9}	0
0.25	5.08×10^{-8}	7.70×10^{-6}	1.09×10^{-5}	7.53×10^{-8}
Median	2.69×10^{-7}	4.70×10^{-5}	5.78×10^{-5}	1.23×10^{-6}
0.75	1.33×10^{-6}	2.68×10^{-4}	3.10×10^{-4}	1.74×10^{-5}
0.9	5.52×10^{-6}	1.25×10^{-3}	1.32×10^{-3}	1.99×10^{-4}
0.95	1.36×10^{-5}	3.29×10^{-3}	3.25×10^{-3}	9.32×10^{-4}
Max	1.98×10^{-3}	5.17×10^{-1}	3.01×10^{-1}	1.00
Mean	4.18×10^{-6}	1.11×10^{-3}	9.95×10^{-4}	1.04×10^{-3}
SD	3.18×10^{-5}	9.01×10^{-3}	6.59×10^{-3}	1.56×10^{-2}

APPENDIX 4-1: DATA AND INACTIVATION CURVES FROM “MICROBIAL CHALLENGES STUDIES AND ESTIMATIONS OF PROCESS TRAIN PERFORMANCE” (1997)

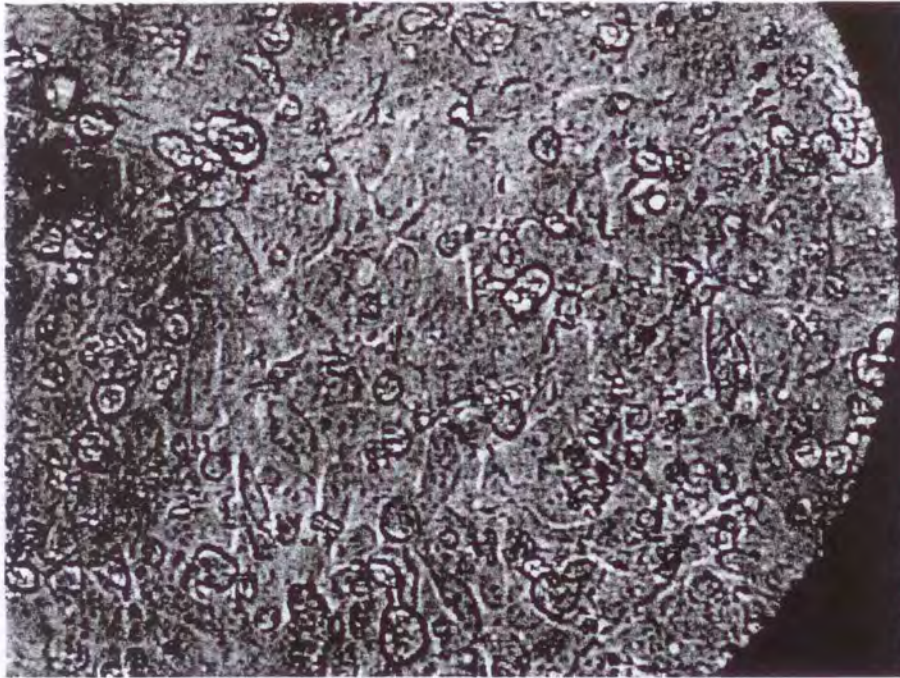

Virus Plaques

MICROBIAL CHALLENGE STUDIES AND ESTIMATION OF PROCESS TRAIN PERFORMANCE

December 1997



The City of San Diego



aqua 2000 Research Center

Prepared by

EOA, Inc.

Eisenberg, Olivieri & Associates
Environmental and Public Health Engineering

**PUBLIC
HEALTH
INSTITUTE**

Table 3
 Summary of 1997 Chlorine Contact - MS-2 Seeding Experiment
 Filtered Secondary Effluent
 Units are Log (pfu/ml) of MS-2 Bacteriophage
 Unless specified otherwise

Sample	Residual Combined Chlorine		Exposure Time Minutes					
	Time 0 mg/L	Time 120 mg/L	0	15	30	60	90	120
A	7.5	2.9	6.56	6.34	-	-	-	6.15
B	7.5	2.2	6.51	6.52	-	-	-	6.04
C	7.5	1.6	6.49	6.26	-	-	-	6.40
D	0.0	0.0	6.59	6.56	-	-	-	6.51
E	11.5	6.0	7.04	6.79	6.74	6.77	6.68	6.36
F	11.5	5.8	7.04	6.90	6.67	6.60	6.38	6.30
G	11.5	7.2	7.15	7.00	6.98	6.80	6.72	6.48
H	0.0	0.0	7.08	7.04	7.08	7.04	7.08	7.11

Note: "-" Means experiment not conducted

Table 4
 Summary of 1997 Chlorine Contact - Polio Virus Seeding Experiment
 Filtered Secondary Effluent
 Units are Log (pfu/ml) of Polio Virus
 Unless specified otherwise

Sample	Residual Combined Chlorine		Exposure Time Minutes					
	Time 0 mg/L	Time 120 mg/L	0	15	30	60	90	120
A	7.5	2.9	4.95	-	-	-	-	>3
B	7.5	2.2	4.85	-	-	-	-	>3
C	7.5	1.6	4.93	-	-	-	-	>3
D	0.0	0.0	4.78	-	-	-	-	4.61
E	11.5	6.0	3.34	3.18	2.81	2.40	2.18	1.30
F	11.5	5.8	3.00	3.00	2.74	2.30	2.28	1.18
G	11.5	7.2	3.30	3.60	2.95	2.74	2.08	1.32
H	0.0	0.0	3.54	-	-	-	-	3.15

Note: "-" Means experiment not conducted

Figure 15
 NCWRP Tertiary Effluent
 Inactivation Curve for MS-2 Bacteriophage
 by Combined Chlorine Contact

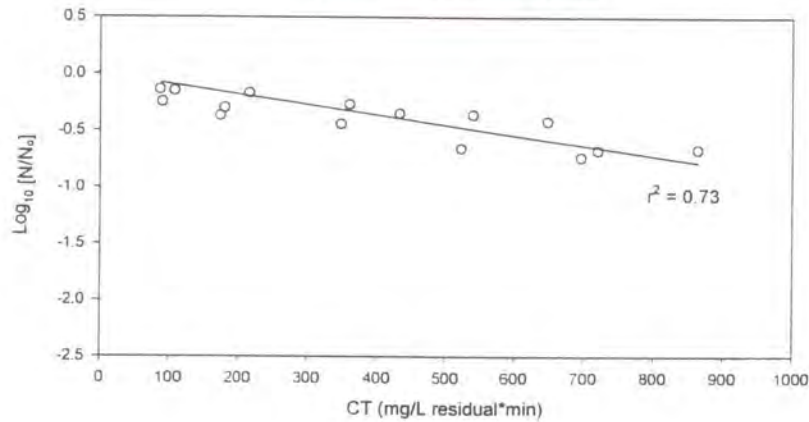
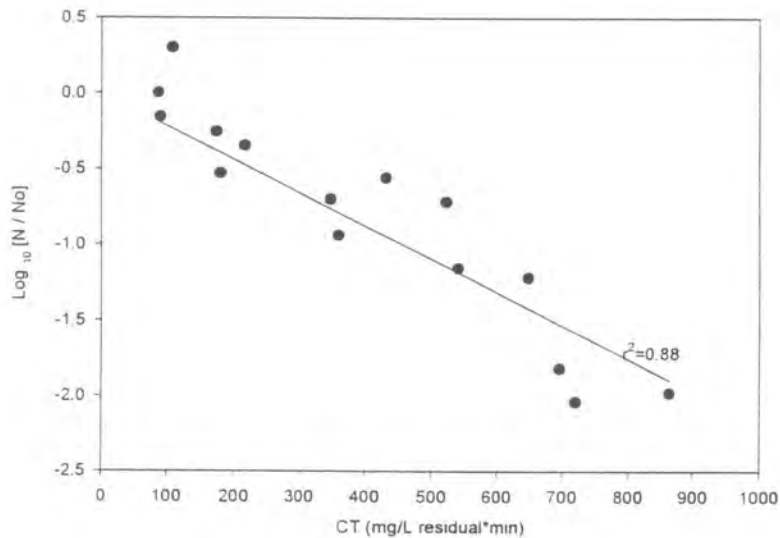

Figure 16
 NCWRP Tertiary Effluent
 Inactivation Curve for Polio Type II Virus
 by Combined Chlorine Contact



5.4.2 AWT Effluent

The purpose of this experiment was to quantify the viricidal effectiveness of free chlorine in the Aqua 2000 AWT effluent with respect to MS-2 and poliovirus type II. The protocol called for two different levels of residual free chlorine at the end of 240 minutes of exposure; 0.5 mg/L and 2.0 mg/L. (Appendix G). Pre-testing conducted at 20° C and without pH adjustment (pH = ~6.0), as prescribed in the experimental protocol determined the applied dose of NaOCl required to achieve the prescribed residuals. In bench scale tests, an applied dose of approximately 35 mg/L was needed to result in a free chlorine residual of 0.5 mg/L after 240 minutes, and that an applied dose of approximately 40 mg/L was required to meet the 2.0 mg/L free chlorine requirement.

The applied doses required to meet the prescribed free chlorine residuals at the end of the experiment were unexpectedly high. A chlorine demand test was conducted on virus-free RO effluent, and it was found that the demand of the RO effluent was approximately 3.5 mg/L. Based on an average of approximately 0.5 mg/L ammonia-N in the RO permeate, as reported in the plant routine monitoring summary (Montgomery Watson, 1997), the reported demand of 3.5 mg/L does not seem unreasonable. It is assumed that the difference between the doses required to meet the stated residuals and the demand of the virus free water is exerted by the culture medium in which the viruses are suspended.

Based on a review of relevant literature and a standard chlorination reference text (White, 1992), it is presumed that the following reactions were occurring during the experiment at their corresponding relative rates: (fast - seconds) formation of monochloramine, reaction of chlorine with virus media, (medium - minutes to hours) reaction of chlorine with virus, formation of dichloramine, and (slow) formation of trichloramine. A summary of the

National Water Research Institute

18700 Ward Street ▪ P.O. Box 8096 ▪ Fountain Valley, California 92728-8096
(714) 378-3278 ▪ Fax: (714) 378-3375 ▪ www.NWRI-USA.org